

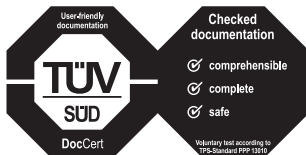

en

## Instructions for use for IMPRESSA A5 One Touch



The Instructions for Use has been awarded the seal of approval by the independent German Technical Inspection Agency, TÜV SÜD, due to its easy-to-understand style, its thoroughness and coverage of safety aspects.



# Your IMPRESSA A5 One Touch

<b>Control elements</b>	<b>34</b>
<b>Important information</b>	<b>36</b>
Proper use .....	36
For your safety .....	36
<b>1 Preparing and using for the first time</b>	<b>38</b>
JURA on the Internet .....	38
3-colour plain text display .....	38
Setting up the machine .....	38
Filling the bean container .....	38
First-time use .....	39
First-time use with filter cartridge activation .....	39
First-time use without filter cartridge activation .....	40
Determining the water hardness .....	40
Filling the water tank .....	41
<b>2 Preparation</b>	<b>41</b>
Espresso, coffee .....	41
Preparing two speciality coffees at the touch of a button .....	41
Latte macchiato, cappuccino .....	42
Permanently setting the amount of water for the cup size .....	42
Ground coffee .....	43
Adjusting the grinder .....	43
Hot water .....	44
<b>3 Daily operation</b>	<b>44</b>
Switching on the machine .....	44
Daily maintenance .....	44
Switching off the machine .....	44
<b>4 Permanent settings in programming mode</b>	<b>45</b>
Products .....	45
Setting the water hardness .....	45
Energy-saving mode .....	46
Automatic switch-off .....	46
Rinses .....	47
Unit for amount of water .....	47
Language .....	48
<b>5 Maintenance</b>	<b>48</b>
Rinsing the machine .....	48
Rinsing the milk system .....	48
Cleaning the milk system .....	49
Dismantling and rinsing the dual spout .....	49
Inserting and activating the filter .....	50
Changing the filter .....	51



Cleaning the machine.....	52
Descaling the machine .....	52
Descaling the water tank.....	53
Cleaning the bean container .....	53
<b>6 Display messages</b>	<b>54</b>
<b>7 Troubleshooting</b>	<b>55</b>
<b>8 Transport and environmentally friendly disposal</b>	<b>56</b>
Transport / Emptying the system .....	56
Disposal .....	56
<b>9 Technical data</b>	<b>56</b>
<b>10 Index</b>	<b>57</b>
<b>11 JURA contact details / Legal information</b>	<b>59</b>

## Symbol description

### Warnings

 <b>WARNING</b>	Always take note of any information marked with the words <b>CAUTION</b> or <b>WARNING</b> and a warning sign. The signal word <b>WARNING</b> draws your attention to potential serious injury, and the signal word <b>CAUTION</b> to potential minor injury.
 <b>CAUTION</b>	
<b>CAUTION</b>	<b>CAUTION</b> draws your attention to potential damage to the machine.

### Symbols used

	<b>Prompt to take action.</b> This symbol means that you are being prompted to perform some action.
	<b>Information</b> and tips to make it even easier to use your IMPRESSA.
	<b>Display</b>

Control elements

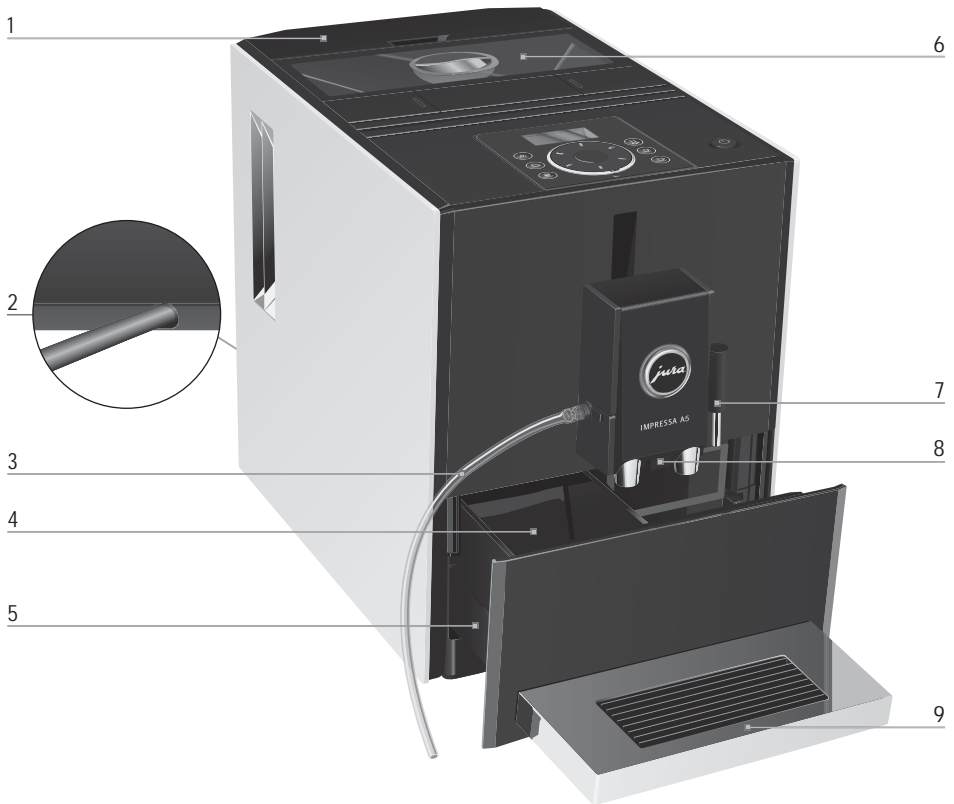

## Control elements





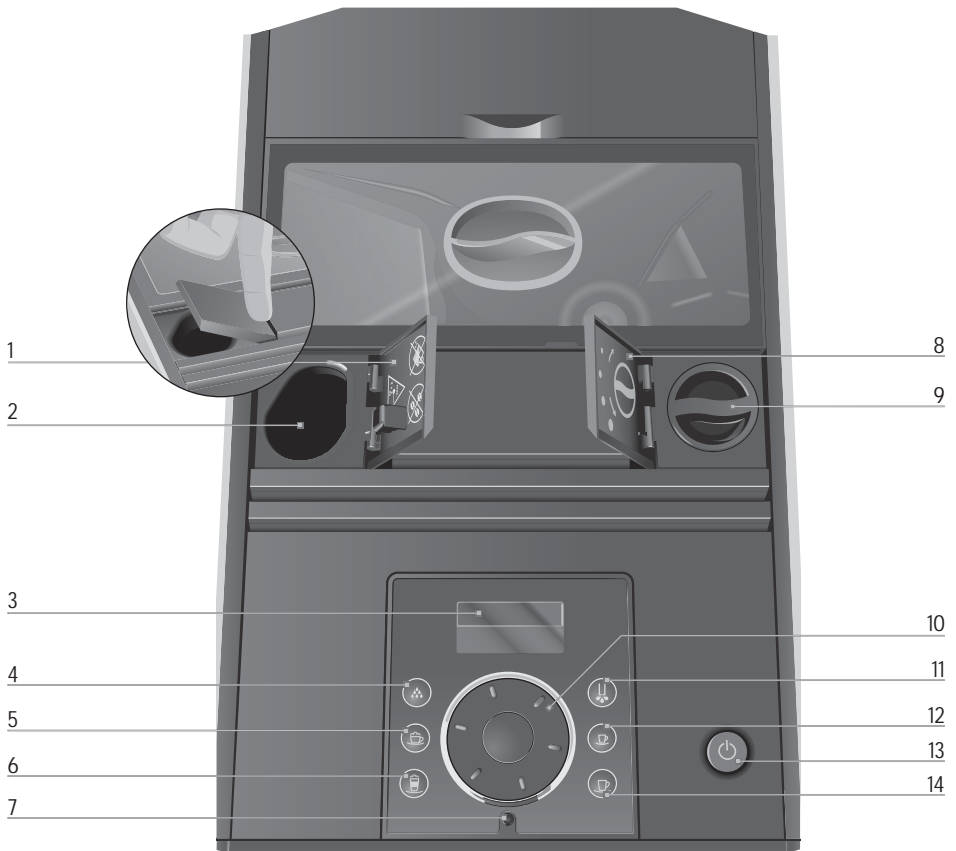

- 1 Water tank
- 2 Mains cable (back of the machine)
- 3 Milk pipe
- 4 Coffee grounds container
- 5 Drip tray

- 6 Bean container with aroma preservation cover
- 7 Hot-water spout
- 8 Height-adjustable dual spout
- 9 Cup grille



- 1 Cover for powder chute for ground coffee
- 2 Powder chute for ground coffee
- 3 Display
- 4  Maintenance button
- 5  Cappuccino button
- 6  Latte Macchiato button
- 7 Rotary Switch status display

- 8 Cover cap for grinder adjustment switch
- 9 Grinder adjustment switch
- 10  Rotary Switch
- 11  Hot Water button
- 12  Espresso button
- 13  On/Off button
- 14  Coffee button

## Important information

### Proper use

The machine is designed and intended for private domestic use. It should only be used for coffee preparation and to heat milk and water. Use for any other purpose will be deemed improper. JURA Elektroapparate AG cannot accept any responsibility for the consequences of improper use.

Before using the machine read these instructions for use thoroughly and completely and comply with the instructions they contain. A warranty service is not applicable for damage or defects caused by non-compliance with the instructions for use. Keep these instructions for use close to the machine and pass them on to the next user.

### For your safety

Please carefully read and observe the important safety information set out below.

To avoid danger of potentially fatal electric shock:

- Never use a machine which is damaged or has a defective mains cable.

- In the event of signs of damage, for example if there is a smell of burning, unplug the machine immediately from the mains supply and contact JURA service.
- If the mains cable of this machine is damaged, it must be repaired either directly by JURA or by an authorised JURA service centre.
- Make sure that the IMPRESSA and the mains cable are not located close to hot surfaces.
- Be careful to ensure that the mains cable is not trapped and does not rub against sharp edges.
- Never open and repair the machine yourself. Do not modify the machine in any way that is not described in these instructions for use. The machine contains live parts. If opened, there is a danger of potentially fatal injury. Repairs may only be carried out by authorised JURA service centres, using original spare parts and accessories.

A defective machine is not safe and could cause injury or fire. To avoid damage and any associated risk of injury or fire:

- Never allow the mains cable to loosely hang down. The mains

- cable could pose a tripping hazard or become damaged.
- Protect the IMPRESSA from environmental influences such as rain, frost and direct sunlight.
- Do not immerse the IMPRESSA, mains cable or connections in water.
- Do not put the IMPRESSA or any individual parts in the dishwasher.
- Before cleaning, switch your IMPRESSA off with the On/Off button. Always wipe the IMPRESSA with a damp cloth rather than a wet one, and protect it from prolonged exposure to water splash.
- Only connect the machine to the mains voltage in accordance with the information on the rating plate. The rating plate is located on the underside of your IMPRESSA. Further technical data is provided in these instructions for use (see Chapter 9 'Technical data').
- Connect the IMPRESSA directly to a domestic power socket. Using multi-socket adapters or extension cords may cause overheating.
- Please only use original JURA maintenance products. Use of products that are not explicitly recommended by JURA could damage the IMPRESSA.
- Do not use any coffee beans treated with additives or caramelised coffee beans.
- Only fill the water tank with fresh, cold water.
- Do not fill the bean container with water.
- Switch the machine off with the On/Off button if you are going to be absent for a longer period of time and remove the mains plug from the power socket.
- Children may not clean or service the machine unless supervised by a responsible person.
- Do not allow children to play with the machine.
- Keep children under the age of 8 away from the machine, or supervise them constantly.
- Children aged 8 and over may only operate the machine without supervision if they have been instructed in how to use it safely. Children must be able to recognise and understand the potential dangers arising from incorrect use.

## 1 Preparing and using for the first time

People, including children, who

- do not have the physical, sensory or mental capabilities to use the machine safely or
- are inexperienced or lack knowledge in how to use the machine safely

must be supervised by a responsible person when using it, or must be instructed in how to use it correctly.

Safety when handling the CLARIS Blue filter cartridge:

- Filter cartridges should be kept out of the reach of children.
- Store filter cartridges in a dry place in the sealed packaging.
- Protect cartridges from heat and direct sunlight.
- Do not use damaged filter cartridges.
- Do not open filter cartridges.

## 1 Preparing and using for the first time

This chapter provides you with the information you need to use your IMPRESSA without any problems. You will prepare your IMPRESSA step-by-step to enjoy your first perfect cup of coffee.

### JURA on the Internet

Visit us on the Internet.

On the JURA website ([www.jura.com](http://www.jura.com)) you will find interesting and up-to-date information on your IMPRESSA and on every aspect of coffee.

### 3-colour plain text display

Your IMPRESSA features a 3-colour plain text display. The colours of the display texts have the following meanings:

- Green: The IMPRESSA is ready for use.
- Red: The IMPRESSA is prompting you to perform some action.
- Yellow: You are in programming mode.

### Setting up the machine

When setting up your IMPRESSA, please note the following:

- Place the machine on a horizontal surface that is not sensitive to water.
- Choose a spot for your IMPRESSA which protects the machine against overheating. Ensure that the ventilation slots are not covered.

### Filling the bean container

---

#### CAUTION

Coffee beans which have been treated with additives (e.g. sugar), ground coffee or freeze-dried coffee will damage the grinder.

- ▶ Only use untreated coffee beans to fill the bean container.
-



- ▶ Remove the aroma preservation cover of the bean container.
- ▶ Remove any dirt or foreign objects from inside the bean container.
- ▶ Fill the bean container with coffee beans.
- ▶ Close the bean container.

### First-time use

When using the machine for the first time, you can choose whether you want to operate IMPRESSA **with** or **without** the CLARIS Blue filter cartridge. If the water hardness is 10° dH or more, we recommend using the filter cartridge. If you do not know the hardness of your water, you can find this out first (see Chapter 1 'Preparing and using for the first time – Determining the water hardness').

- i** The On/Off button also acts as a power switch. When the IMPRESSA is switched off, the machine does not consume standby energy.

### **⚠** WARNING

If the machine is operated with a defective mains cable, there is a danger of potentially fatal electric shock.

- ▶ Never use a machine which is damaged or has a defective mains cable.

**Precondition:** Bean container is filled.

- ▶ Insert the mains plug into a power socket.
- ⏻** ▶ Press the On/Off button to switch the machine on.  
SPRACHE DEUTSCH
- ⌚** ▶ Turn the Rotary Switch until the required language is displayed, for example LANGUAGE ENGLISH.



- ⌚** ▶ Press the Rotary Switch to confirm the language setting.

OK, the language is set.  
FILTER ✓ / YES ✓

- i** Now decide whether you want to operate your IMPRESSA **with** or **without** a CLARIS Blue filter cartridge.

### First-time use with filter cartridge activation

- ⌚** ▶ Press the Rotary Switch.

OK  
INSERT FILTER

- ▶ Remove the water tank.
- ▶ Open the filter holder.
- ▶ Insert the filter cartridge into the water tank, exerting slight pressure.

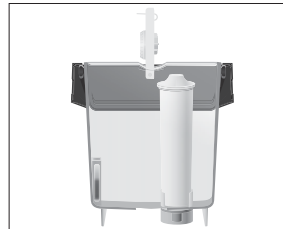

- ▶ Close the filter holder. It will click into place audibly.

- i** After two months, the filter will cease to work. Set the date on the date plate on the filter holder in the water tank.



- ▶ Fill the water tank with fresh, cold water and reinsert it.
- ▶ Place a receptacle (at least 500 ml) under the hot-water and dual spout.



en

## 1 Preparing and using for the first time

 ▶ Press the Rotary Switch.  
**FILTER RINSING**, water flows out of the hot-water spout.

 You can interrupt rinsing of the filter at any time by pressing any button. Press the Maintenance button , to continue with rinsing of the filter.

 The water may be slightly discoloured. This is not harmful to health and does not affect the taste.

Rinsing of the filter stops automatically.

**SYSTEM FILLING**, water flows out of the dual spout.

**HEATING**

**RINSING**, the system rinses itself. The operation stops automatically.

**READY**

▶ Fill the water tank with fresh, cold water and reinsert it.

**PRESSE RINSE**

▶ Place a receptacle under the hot- water spout and the dual spout.



 ▶ Press the Maintenance button.

**SYSTEM FILLING**, the system fills up with water.

**HEATING**

**RINSING**, the system rinses itself. The operation stops automatically.

**READY**

## First-time use without filter cartridge activation

 ▶ Turn the Rotary Switch until **FILTER -- / NO --** is displayed.

 ▶ Press the Rotary Switch.

**OK**

**16 ° dH**

 ▶ Turn the Rotary Switch to change the water hardness setting, e.g. to **25 ° dH**.

 ▶ Press the Rotary Switch.

**OK**

**FILL WATER TANK**

▶ Remove the water tank.



## Determining the water hardness

You can find out what the water hardness is by using the Aquadur® test strip supplied as standard.

▶ Hold the test strip briefly (for one second) under running water.

▶ Shake off the water.

▶ Wait for about one minute.

▶ You will then be able to read the degree of water hardness from the discolouration of the Aquadur® test strip and the description on the packaging.

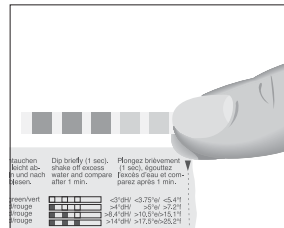

The water hardness can now be set.

## Filling the water tank

Daily maintenance of the machine and hygiene when handling milk, coffee and water are key to a perfect coffee result in the cup every time. You should therefore change the water **daily**.

### CAUTION

Milk, sparkling mineral water or other liquids can damage the water tank or the machine.

- ▶ Only fill the water tank with fresh, cold water.
- ▶ Remove the water tank and rinse with cold water.



- ▶ Fill the water tank with fresh, cold water and reinsert it.

## 2 Preparation

- i** You can interrupt preparation at any time while a speciality coffee, speciality coffee with milk or hot water is being prepared. Just press any button.
- i** Before and during the grinding operation you can select the **coffee strength** of espresso ☞, coffee ☞, cappuccino ☞ and latte macchiato ☞: **NORMAL, STRONG**.
- i** During preparation, you can change the preset **amounts** (e.g. amount of milk foam or water) by turning the Rotary Switch ⦿.
- i** You can follow the current status of preparation on the progress bar.

Coffee tastes best served hot. A cold porcelain cup cools the beverage – and impairs the taste. We therefore recommend prewarming the cups. The full coffee aroma can develop only in prewarmed cups. You can purchase a JURA cup warmer from your specialised dealer.

You can make permanent settings for all products in programming mode (see Chapter 4 'Permanent settings in programming mode – Products').

### Espresso, coffee

Preparation of espresso ☞ and coffee ☞ follows this model.

**Example:** Proceed as follows to prepare one coffee.

**Precondition:** **READY** is displayed.

- ▶ Place a cup under the dual spout.
- ☞ ▶ Press the Coffee button to start preparation.  
**COFFEE**, the preset amount of water flows into the cup.  
Preparation stops automatically.  
**READY**

### Preparing two speciality coffees at the touch of a button

The preparation of 2 espressi and 2 coffees follows this same model.

**Example:** Prepare two espressi.

**Precondition:** **READY** is displayed.

- ▶ Place two espresso cups under the dual spout.
- ☞ ▶ Press the Espresso button **twice** (within two seconds) to start preparation.  
**2 ESPRESSI**, the preset amount of water flows into the cups.
- i** Please note that the desired speciality coffee is prepared twice in succession.  
Preparation stops automatically.  
**READY**

## 2 Preparation

### Latte macchiato, cappuccino

Your IMPRESSA can prepare a latte macchiato or cappuccino at the touch of a button. There is no need to move the glass or cup.

Latte macchiato ☕ and cappuccino ☕ are prepared following this model.

**Example:** Proceed as follows to prepare one latte macchiato.

**Precondition:** READY is displayed.

- ▶ Place a glass under the dual spout.
- ▶ Remove the protective cover of the dual spout.
- ▶ Connect the milk pipe to the dual spout.

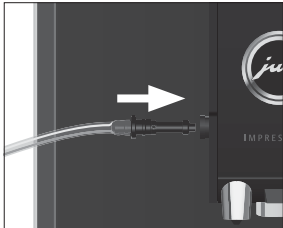

- ▶ Immerse the other end of the milk pipe in a receptacle with milk (figure: optional stainless steel vacuum milk container, 0.4 litres, from JURA).

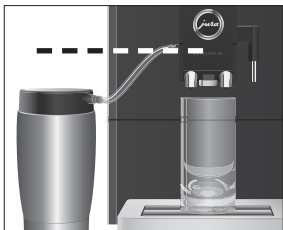

**i** Ensure that the filling height of the milk is **no higher** than the milk pipe connection on the dual spout.

- ☕ ▶ Press the Latte Macchiato button.  
LATTE MAC., the milk foam is prepared.  
Preparation stops automatically when the preset amount of milk is reached.  
PAUSE

**i** There is a short interval while the hot milk separates from the milk foam. This allows the typical layers of a latte macchiato to form. You can choose the length of this interval in programming mode (see Chapter 4 'Permanent settings in programming mode – Products').

LATTE MAC., coffee preparation starts.  
The preset amount of water flows into the glass.  
Preparation stops automatically.  
READY

To ensure that the milk system in the dual spout always works properly, you must clean it **daily** (see Chapter 5 'Maintenance – Cleaning the milk system').

### Permanently setting the amount of water for the cup size

It is easy to make permanent settings for the amount of water for all speciality coffees and hot water according to the cup size. Adjust the amount once as shown in the following example. Every time you prepare a drink in the future, this amount of water will be dispensed.

**Example: Permanently** adjust the amount of cappuccino to the cup size.

**Precondition:** READY is displayed. Milk is connected to the dual spout.

- ▶ Place a cup under the dual spout.
- ☕ ▶ Press and **hold** the Cappuccino button until ENOUGH MILK? appears.
- ☕ ▶ **Release** the Cappuccino button.  
The milk foam is prepared.
- ▶ Press any button as soon as there is sufficient milk foam in the cup.  
OK  
ENOUGH COFFEE?, the coffee flows into the cup.

- ▶ Press any button as soon as there is sufficient coffee in the cup.

OK, CAPPUCCINO, the set amounts for one cappuccino are permanently stored.

READY

- i** You can alter this setting at any time by repeating the above procedure.

## Ground coffee

You can choose to use a second coffee variety, for example decaffeinated coffee, with the powder chute for ground coffee.

- i** Never add more than one level measuring spoon of ground coffee.
- i** It is not possible to prepare 2 espressos or 2 coffees with ground coffee.
- i** Use ground coffee which is not ground too finely. Very fine coffee can block up the system so that the coffee only comes out in drips.
- i** If you did not add a sufficient amount of ground coffee, NOT ENOUGH POWDER is displayed and the IMPRESSA stops the operation.
- i** The desired speciality coffee must be prepared within approximately one minute after filling with the ground coffee. Otherwise the IMPRESSA stops the operation and is once more ready for use.

The preparation of coffee, espresso, cappuccino and latte macchiato with ground coffee follows this model.

**Example:** Prepare a cup of coffee using ground coffee.

**Precondition:** READY is displayed.

- ▶ Place a cup under the dual spout.
- ▶ Open the powder chute for ground coffee.

FILL POWDER

- ▶ Place the filler funnel for ground coffee on the powder chute.

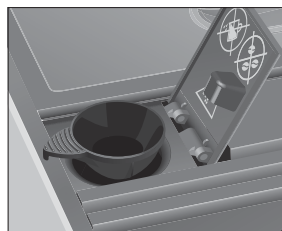

- ▶ Place one level measuring spoon of ground coffee into the filler funnel.
- ▶ Close the powder chute for ground coffee.

SELECT BUTTON

- C** ▶ Press the Coffee button to start preparation. COFFEE, the preset amount of water flows into the cup.

Preparation stops automatically.

READY

## Adjusting the grinder

You can adjust the grinder on a continuous scale to suit the degree of roast of your coffee.

### CAUTION

If you adjust the consistency of grind when the grinder is not operating, the grinder adjustment switch could be damaged.

- ▶ Only adjust the consistency of grind when the grinder is running.

The consistency of grind is correct if the coffee flows regularly from the dual spout. In addition a fine, thick crema forms.

**Example:** Change the consistency of grind **during** the preparation of an espresso.

- ▶ Place a cup under the dual spout.

### 3 Daily operation

- ▶ Open the cover of the grinder adjustment switch.

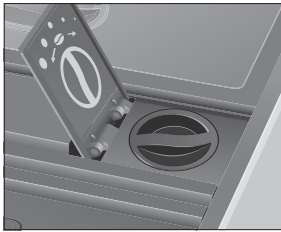

- ▶ Press the Espresso button to start preparation.
- ▶ Turn the grinder adjustment switch to the desired position **while** the grinder is running.  
The preset amount of water flows into the cup. Preparation stops automatically.

READY

### Hot water

#### CAUTION

There is a danger of scalding from hot water splashes.

- ▶ Avoid direct contact with the skin.

**Precondition:** READY is displayed.

- ▶ Place a cup under the hot-water spout.
- ▶ Press the Hot Water button.  
WATER, the preset amount of water flows into the cup.  
Preparation stops automatically.

READY

## 3 Daily operation

### Switching on the machine

Daily maintenance of the machine and hygiene when handling milk, coffee and water are key to a perfect coffee result in the cup every time. You should therefore change the water **daily**.

When the IMPRESSA is switched on, a rinse operation is automatically initiated. In programming mode you can change this setting so that the machine prompts you to perform the switch-on rinse, which must be started by pressing the Maintenance button  (see Chapter 4 'Permanent settings in programming mode – Rinses').

- ▶ Place a receptacle under the dual spout.
- ▶ Press the On/Off button to switch the machine on.

HEATING

RINSING, the system rinses itself. The operation stops automatically.

READY

### Daily maintenance

To ensure that you get many years of reliable service out of your IMPRESSA and to guarantee the optimum coffee quality, the machine requires daily maintenance.

- ▶ Remove the drip tray.
- ▶ Empty the coffee grounds container and drip tray and rinse with warm water.
- ▶ Reinsert the coffee grounds container and the drip tray.
- ▶ Rinse the water tank with clean water.
- ▶ Dismantle and rinse the dual spout (see Chapter 5 'Maintenance – Dismantling and rinsing the dual spout').
- ▶ Wipe the surface of the machine with a clean, soft, damp cloth (e.g. microfibre cloth).

- i** In the interests of hygiene, we recommend changing the milk pipe on a regular basis (approx. every 3 months). Replacement pipes are available from specialised dealers.

### Switching off the machine

When the IMPRESSA is switched off, the system is automatically rinsed if a speciality coffee has been prepared. If cappuccino or latte macchiato has been prepared, cappuccino frother rinsing also takes place.

- ▶ Place a receptacle under the dual spout.
- ▶ Press the On/Off button.  
RINSING, CAPPUCCINO  
RINSING, the system rinses itself. The operation stops automatically. Your IMPRESSA is switched off.
- i** When the IMPRESSA is switched off with the On/Off button, the machine does **not** consume standby energy.

## 4 Permanent settings in programming mode

### Products

You can make the following permanent settings for **espresso** and **coffee**:

- Amount of water: 25 ML – 240 ML
- Coffee strength: NORMAL, STRONG
- Temperature: NORMAL, HIGH

You can make the following permanent settings for **latte macchiato** and **cappuccino**:

- Amount of milk foam: 3 SEC – 120 SEC
- Interval: 0 SEC – 60 SEC
- Coffee strength: NORMAL, STRONG
- Amount of water: 25 ML – 240 ML
- Temperature: NORMAL, HIGH

You can make the following permanent setting for **hot water**:

- Amount of water: 25 ML – 450 ML

Permanent settings in programming mode always follow the same model.

**Example:** Permanently change the coffee strength (FLAVOUR) for espresso from STRONG to NORMAL.

**Precondition:** READY is displayed.

- ▶ Press **and hold** the Rotary Switch until RINSE appears.
- ▶ Turn the Rotary Switch until PRODUCT is displayed.

- ▶ Press the Rotary Switch to enter the programme item.  
SELECT BUTTON
- i** Next select the button of the product for which you would like to make settings. No product is prepared at this point.
- ▶ Press the Espresso button.  
ESPRESSO  
WATER
- ▶ Turn the Rotary Switch until FLAVOUR is displayed.
- ▶ Press the Rotary Switch to enter the programme item.  
STRONG
- ▶ Turn the Rotary Switch until NORMAL is displayed.
- ▶ Press the Rotary Switch to confirm the setting.  
OK, the coffee strength is set.  
FLAVOUR
- ▶ Turn the Rotary Switch until EXIT is displayed.
- ▶ Press the Rotary Switch to exit the programme item.  
PRODUCT
- ▶ Turn the Rotary Switch until EXIT is displayed.
- ▶ Press the Rotary Switch to exit programming mode.  
READY

### Setting the water hardness

- i** If you are using the CLARIS Blue filter cartridge and have activated it in programming mode, you will not be able to adjust the water hardness.

The harder the water is, the more frequently the IMPRESSA needs to be descaled. It is therefore important to set the water hardness accurately.

The water hardness can be adjusted on a continuous scale between 1° dH and 30° dH.

#### 4 Permanent settings in programming mode

**Example:** Change the water hardness setting from 16 °dH to 25 °dH.

**Precondition:** READY is displayed.

- ▶ Press **and hold** the Rotary Switch until RINSE appears.
- ▶ Turn the Rotary Switch until HARDNESS is displayed.
- ▶ Press the Rotary Switch to enter the programme item.  
16 °dH
- ▶ Turn the Rotary Switch until 25 °dH is displayed.
- ▶ Press the Rotary Switch to confirm the setting.  
OK, the water hardness is set.  
HARDNESS
- ▶ Turn the Rotary Switch until EXIT is displayed.
- ▶ Press the Rotary Switch to exit programming mode.  
READY

#### Energy-saving mode

The energy-saving mode (Energy Save Mode, E.S.M.®) helps you to prevent your machine from consuming power unnecessarily and to actively save energy:

- ENERGY ♪
  - Soon after the last preparation, the IMPRESSA stops heating up. After about 5 minutes the message ENERGY ON is displayed.
  - Before you can prepare a speciality coffee, speciality coffee with milk, or hot water, the machine must heat up.
- ENERGY –
  - The IMPRESSA is constantly ready for use.
  - All speciality coffees as well as hot water can be prepared without having to wait.

**Example:** Change energy-saving mode from ENERGY ♪ to ENERGY –.

**Precondition:** READY is displayed.

- ▶ Press **and hold** the Rotary Switch until RINSE appears.
- ▶ Turn the Rotary Switch until ENERGY ♪ is displayed.
- ▶ Press the Rotary Switch to enter the programme item.  
ECONOMY ♪
- ▶ Turn the Rotary Switch until ECONOMY – is displayed.
- ▶ Press the Rotary Switch to confirm the setting.  
OK, energy-saving mode is set.  
ENERGY –
- ▶ Turn the Rotary Switch until EXIT is displayed.
- ▶ Press the Rotary Switch to exit programming mode.  
READY

#### Automatic switch-off

By instructing your IMPRESSA to automatically switch itself off, you can cut down your energy consumption. If this function is activated, your IMPRESSA switches off automatically after the preset time following the last action on the machine.

The automatic switch-off can be set to between 15 minutes and 9 hours.

**Example:** Change the switch-off time from 2 HRS to 1 HRS.

**Precondition:** READY is displayed.

- ▶ Press **and hold** the Rotary Switch until RINSE appears.
- ▶ Turn the Rotary Switch until OFF AFTER is displayed.
- ▶ Press the Rotary Switch to enter the programme item.  
2 HRS
- ▶ Turn the Rotary Switch until 1 HRS is displayed.



- ▶ Press the Rotary Switch to confirm the setting.  
OK, the switch-off time is set.  
OFF AFTER
- ▶ Turn the Rotary Switch until EXIT is displayed.
- ▶ Press the Rotary Switch to exit programming mode.  
READY

## Rinses

In the programme item RINSES you can make the following settings:

- INIT RINSE MANUAL
  - The switch-on rinse must be started manually.
- INIT RINSE AUTOMATIC
  - The switch-on rinse is started automatically.
- C-RINSE AFTER 10'
  - You are prompted to perform a cappuccino rinse 10 minutes after preparation of a speciality coffee with milk.
- C-RINSE NOW
  - You are prompted to perform a cappuccino rinse immediately after preparation of a speciality coffee with milk.

**Example:** Change the setting such that cappuccino frother rinsing is performed **immediately** after preparation of a speciality coffee with milk.

**Precondition:** READY is displayed.

- ▶ Press **and hold** the Rotary Switch until RINSE appears.
- ▶ Turn the Rotary Switch until RINSES is displayed.
- ▶ Press the Rotary Switch to enter the programme item.  
INIT RINSE
- ▶ Turn the Rotary Switch until C-RINSE is displayed.
- ▶ Press the Rotary Switch to enter the programme item.  
AFTER 10'

- ▶ Turn the Rotary Switch until NOW is displayed.
- ▶ Press the Rotary Switch to confirm the setting.  
OK  
C-RINSE
- ▶ Turn the Rotary Switch until EXIT is displayed.
- ▶ Press the Rotary Switch to exit the programme item.  
RINSES
- ▶ Turn the Rotary Switch until EXIT is displayed.
- ▶ Press the Rotary Switch to exit programming mode.  
READY

## Unit for amount of water

You can change the unit for the amount of water from 'ml' to 'oz'.

**Example:** Change the unit for the amount of water from ML to OZ.

**Precondition:** READY is displayed.

- ▶ Press **and hold** the Rotary Switch until RINSE appears.
- ▶ Turn the Rotary Switch until DISPLAY is displayed.
- ▶ Press the Rotary Switch to enter the programme item.  
ML
- ▶ Turn the Rotary Switch until OZ is displayed.
- ▶ Press the Rotary Switch to confirm the setting.  
OK, the unit for the amount of water is set.  
DISPLAY
- ▶ Turn the Rotary Switch until EXIT is displayed.
- ▶ Press the Rotary Switch to exit programming mode.  
READY

## 5 Maintenance

### Language

In this programme item you can set the language used by your IMPRESSA.

**Example:** Change the language from ENGLISH to DEUTSCH.

**Precondition:** READY is displayed.

- ⌚ ▶ Press **and hold** the Rotary Switch until RINSE appears.
- ⌚ ▶ Turn the Rotary Switch until LANGUAGE is displayed.
- ⌚ ▶ Press the Rotary Switch to enter the programme item.  
ENGLISH
- ⌚ ▶ Turn the Rotary Switch until DEUTSCH is displayed.
- ⌚ ▶ Press the Rotary Switch to confirm the setting.  
OK, the language is set.  
SPRACHE
- ⌚ ▶ Turn the Rotary Switch until EXIT is displayed.
- ⌚ ▶ Press the Rotary Switch to exit programming mode.  
BEREIT

## 5 Maintenance

Your IMPRESSA has the following integrated maintenance programmes:

- Cappuccino frother cleaning (C-CLEAN)
- Rinsing the machine (RINSE)
- Cappuccino frother rinsing (C-RINSE)
- Cleaning the machine (CLEAN)
- Changing the filter (FILTER)
- Descaling the machine (DE-SCALE)

**i** You can start the maintenance programmes at any time in programming mode (programme item RINSE). If no action is taken in this programme item, programming mode is exited automatically after approximately 5 seconds.

### Rinsing the machine

You can initiate the rinse operation manually at any time.

**Precondition:** READY is displayed.

- ▶ Place a receptacle under the dual spout.



- ⌚ ▶ Press **and hold** the Rotary Switch until RINSE appears.
- ⌚ ▶ Press the Rotary Switch to enter the programme item.  
C-CLEAN
- ⌚ ▶ Turn the Rotary Switch until RINSE is displayed.
- ⌚ ▶ Press the Rotary Switch to initiate the rinse operation.  
RINSING, the system rinses itself. The operation stops automatically.  
READY

### Rinsing the milk system

After each milk preparation, the IMPRESSA prompts you to perform a cappuccino rinse.

**Precondition:** CAPPUCCINO RINSE is displayed.

- ▶ Place a receptacle under the dual spout.



- ▶ Press the Rotary Switch to start cappuccino frother rinsing.  
**CAPPUCCINO RINSING**, the milk system is rinsed.  
 The rinse stops automatically. **READY** appears on the display.

## Cleaning the milk system

The dual spout must be cleaned **daily** if milk has been prepared to make sure it functions perfectly and also in the interests of hygiene. Your IMPRESSA will **not** prompt you to clean the dual spout.

### CAUTION

If the wrong cleaning agent is used, the machine could be damaged and/or traces could be left behind in the milk.

- ▶ Use only original JURA maintenance products.

**i** JURA Cappuccino Cleaner is available from specialised dealers.

- ▶ Press **and hold** the Rotary Switch until **RINSE** appears.
- ▶ Press the Rotary Switch to enter the programme item.  
**C-CLEAN**
- ▶ Press the Rotary Switch to start cappuccino frother cleaning.  
**CLEANER FOR CAPPU.**
  - ▶ Remove the milk pipe from the receptacle with milk.
  - ▶ Pour 250 ml of fresh water into a receptacle and add one capful (max. 15 ml) of Cappuccino Cleaner.
  - ▶ Immerse the milk pipe in the receptacle.

- ▶ Place another receptacle under the dual spout.

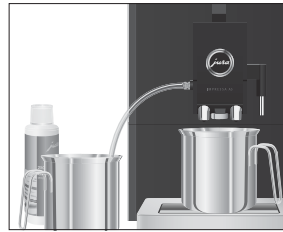

- ▶ Press the Rotary Switch.  
**CLEANING**, the milk system and the pipe are cleaned.  
 The operation is interrupted, **WATER FOR CAPPUCCINO**.
- ▶ Rinse the receptacle thoroughly, fill it with 250 ml of fresh water and immerse the milk pipe in it.
- ▶ Empty the receptacle under the dual spout and place it back underneath.
- ▶ Press the Rotary Switch.  
**CLEANING**, the milk system and the pipe are rinsed with fresh water.  
 The operation stops automatically.  
**READY**

## Dismantling and rinsing the dual spout

The dual spout must be dismantled and rinsed **daily** if milk has been prepared to make sure it functions perfectly and also in the interests of hygiene. Your IMPRESSA will not prompt you to clean the dual spout.

- ▶ Remove the milk pipe and rinse thoroughly under running water.
- ▶ Press the releasing devices and pull the dual spout down and off.

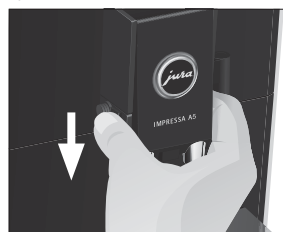

## 5 Maintenance

- ▶ Push the milk system down and remove it.

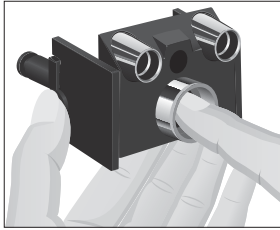

- ▶ Dismantle the milk system into its individual parts.

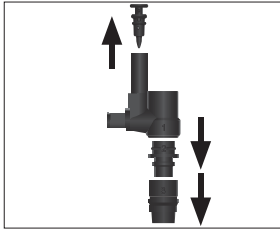

- ▶ Rinse all parts under running water. If there are severely dried on milk residues, firstly immerse the individual parts in JURA Cappuccino Cleaner and then clean them thoroughly.
- ▶ Fit the air intake pipe.

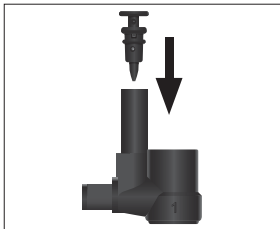

- ▶ Reassemble the milk system, noting the numbering on the parts.

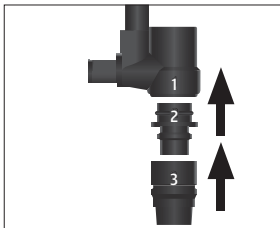

- ▶ Insert the assembled individual parts into the dual spout and press them together.
- ▶ Fit the dual spout on the machine. It will click into place audibly.

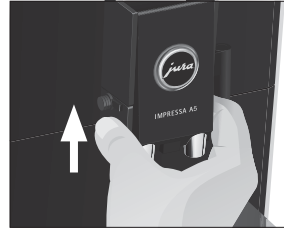





### Inserting and activating the filter

Your IMPRESSA no longer has to be descaled if you are using the CLARIS Blue filter cartridge. If you did not activate the filter cartridge the first time you used the machine, you can do this now as follows.

- i** Perform the 'inserting the filter' operation without any interruptions. This will ensure that your IMPRESSA always produces its best.

**Precondition:** READY is displayed.

-  ▶ Press **and hold** the Rotary Switch until RINSE appears.
-  ▶ Turn the Rotary Switch until FILTER --- is displayed.
-  ▶ Press the Rotary Switch to enter the programme item.  
NO ---
-  ▶ Turn the Rotary Switch until YES ✓ is displayed.
-  ▶ Press the Rotary Switch to confirm the setting.  
OK  
INSERT FILTER
- ▶ Remove and empty the water tank.
- ▶ Open the filter holder.

- ▶ Insert the filter cartridge into the water tank, exerting slight pressure.

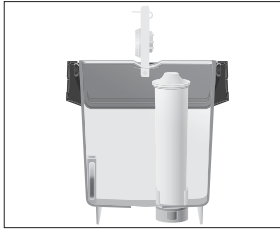

- ▶ Close the filter holder. It will click into place audibly.

**i** After two months, the filter will cease to work. Set the date on the date plate on the filter holder in the water tank.

- ▶ Fill the water tank with fresh, cold water and reinsert it.
- ▶ Place a receptacle (at least 500 ml) under the hot-water spout.



- ▶ Press the Rotary Switch.

FILTER RINSING, water flows out of the hot-water spout.

**i** You can interrupt rinsing of the filter at any time by pressing any button. Press the Maintenance button , to continue with rinsing of the filter.

**i** The water may be slightly discoloured. This is not harmful to health and does not affect the taste.

Rinsing of the filter stops automatically.

HEATING

READY

The filter is now activated.

## Changing the filter

**i** After 50 litres of water have flowed through, the filter will cease to work. Your IMPRESSA will automatically prompt you to change the filter.

**i** After two months, the filter will cease to work. Set the date on the date plate on the filter holder in the water tank.

**i** If the CLARIS Blue filter cartridge is not activated in programming mode, you will not be prompted to change the filter.

**Precondition:** FILTER / READY is displayed.

- ▶ Press the Maintenance button.

INSERT FILTER

- ▶ Remove and empty the water tank.
- ▶ Open the filter holder and remove the old filter cartridge.
- ▶ Insert a new filter cartridge into the water tank, exerting slight pressure.

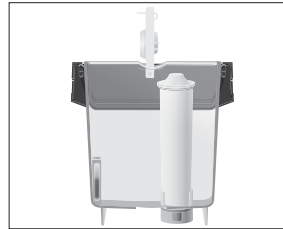

- ▶ Close the filter holder. It will click into place audibly.
- ▶ Fill the water tank with fresh, cold water and reinsert it.
- ▶ Place a receptacle (at least 500 ml) under the hot-water spout.



- ▶ Press the Rotary Switch.

FILTER RINSING, water flows out of the hot-water spout.

**i** You can interrupt rinsing of the filter at any time by pressing any button. Press the Maintenance button , to continue with rinsing of the filter.

**i** The water may be slightly discoloured. This is not harmful to health and does not affect the taste.

Rinsing of the filter stops automatically.

HEATING

READY

## Cleaning the machine

After 180 preparations or 80 switch-on rinses, the IMPRESSA will prompt you to clean it.

### CAUTION

If the wrong cleaning agent is used, the machine could be damaged and/or traces could be left behind in the water.

- ▶ Use only original JURA maintenance products.

- i** The cleaning programme lasts approximately 15 minutes.
- i** Do not interrupt the cleaning programme. The quality of cleaning will be impaired if you do so.
- i** JURA cleaning tablets are available from specialised dealers.

**Precondition:** CLEAN / READY is displayed.

- ❖ ▶ Press the Maintenance button.  
EMPTY TRAY
- ▶ Empty the drip tray and coffee grounds container and reinsert them.  
PRESS RINSE
- ▶ Place a receptacle under the dual spout.
- ❖ ▶ Press the Maintenance button.  
CLEANING, water flows out of the dual spout.  
The operation is interrupted, ADD TABLET.
- ▶ Open the powder chute for ground coffee and drop in a JURA cleaning tablet.

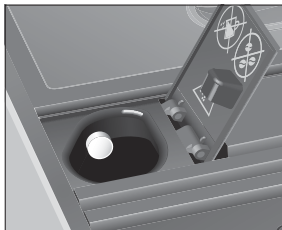

- ▶ Close the powder chute for ground coffee.  
PRESS RINSE

- ❖ ▶ Press the Maintenance button.  
CLEANING, water flows out of the dual spout repeatedly.  
EMPTY TRAY
- ▶ Empty the drip tray and coffee grounds container and reinsert them.  
HEATING  
READY

## Descaling the machine

The IMPRESSA builds up deposits of limescale over time and automatically prompts you to descale it when necessary. The degree of calcification depends on the hardness of your water.

### ⚠ CAUTION

- If the descaling agent comes into contact with the skin or eyes, this can cause irritation.
- ▶ Avoid contact with the skin or eyes.
  - ▶ Rinse off the descaling agent with clean water. Should you get any descaling agent in your eye, see a doctor.

### CAUTION

- If the wrong descaling agent is used, the machine could be damaged and/or traces could be left behind in the water.
- ▶ Use only original JURA maintenance products.

### CAUTION

- If the descaling operation is interrupted, there may be damage to the machine.
- ▶ Allow the descaling programme to run to the end.

### CAUTION

- If the descaling agent comes into contact with sensitive surfaces (e.g. marble), damage cannot be ruled out.
- ▶ Clean up any splashes immediately.

- i** The descaling programme lasts approximately 40 minutes.

- i** JURA descaling tablets are available from specialised dealers.
- i** If you use a CLARIS Blue filter cartridge and this is activated, you will not be prompted to descale.

**Precondition:** DE-SCALE / READY is displayed.

- ❖ ▶ Press the Maintenance button.  
EMPTY TRAY
- ▶ Empty the drip tray and coffee grounds container and reinsert them.
- AGENT IN TANK
- ▶ Remove and empty the water tank.
- ▶ Completely dissolve the contents of one blister (three JURA descaling tablets) in a receptacle holding 500 ml of water. This may take several minutes.

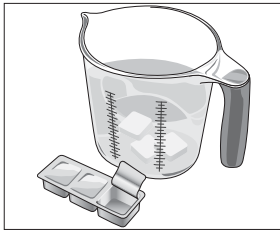

- ▶ Pour the solution into the **empty** water tank and reinsert the tank.

PRESS RINSE

- ▶ Place a receptacle under the hot-water spout.
- ❖ ▶ Press the Maintenance button.  
DE-SCALING, water flows out of the hot-water spout repeatedly.  
EMPTY TRAY
- ▶ Empty the drip tray and coffee grounds container and reinsert them.
- FILL WATER TANK
- ▶ Empty the receptacle and place it under the dual and hot-water spout.
- ▶ Remove the water tank, rinse thoroughly, fill with fresh, cold water and reinsert.

PRESS RINSE

- ❖ ▶ Press the Maintenance button.  
DE-SCALING, water flows out of the dual and hot-water spout.  
The operation is interrupted, EMPTY TRAY.
- ▶ Empty the drip tray and coffee grounds container and reinsert them.  
READY

- i** If the descaling operation stops unexpectedly, rinse the water tank thoroughly.

## Descaling the water tank

Limescale deposits may form in the water tank. To ensure correct function of the machine, descale the water tank from time to time.

- ▶ Remove the water tank.
- ▶ If you use a CLARIS Blue filter cartridge, remove it.
- ▶ Descal the tank with a mild conventional descaling agent in accordance with the manufacturer's instructions.
- ▶ Rinse the water tank thoroughly.
- ▶ If you use a CLARIS Blue filter cartridge, reinsert it.
- ▶ Fill the water tank with fresh, cold water and reinsert it.

## Cleaning the bean container

Coffee beans may be covered with a slight oil film which remains on the walls of the bean container. These traces may negatively affect the coffee result. For this reason clean the bean container from time to time.

- ⏻ ▶ Press the On/Off button to switch the machine off.
- ▶ Disconnect the mains plug.
- ▶ Remove the bean container cover.
- ▶ Remove the coffee beans with a vacuum cleaner.
- ▶ Clean the bean container with a soft, dry cloth.
- ▶ Fill the bean container with fresh coffee beans, then close the bean container cover.

## 6 Display messages

Message	Cause/Result	Action
FILL WATER TANK	The water tank is empty or not correctly inserted. You cannot prepare any products.	<ul style="list-style-type: none"> <li>▶ Fill the water tank (see Chapter 1 'Preparing and using for the first time – Filling the water tank').</li> <li>▶ Insert the water tank.</li> </ul>
EMPTY GROUNDS	The coffee grounds container is full. No speciality coffees can be prepared, but hot water preparation is possible.	▶ Empty the coffee grounds container and the drip tray (see Chapter 3 'Daily operation – Daily maintenance').
TRAY MISSING	The drip tray is not inserted correctly or is not inserted at all. You cannot prepare any products.	▶ Insert the drip tray.
FILL BEANS	The bean container is empty. No speciality coffees can be prepared, but hot water preparation is possible.	▶ Fill the bean container (see Chapter 1 'Preparing and using for the first time – Filling the bean container').
CLOSE COVER	The aroma preservation cover for the bean container is not fitted or not fitted correctly.	▶ Fit the aroma preservation cover correctly.
PRESS RINSE	The IMPRESSA is prompting you to perform a rinse or continue a maintenance programme that was already started.	▶ Press the Maintenance button to start the rinse or to continue the maintenance programme.
CAPPUCCINO RINSE	The IMPRESSA requests a cappuccino rinse.	▶ Press the Maintenance button to start cappuccino frother rinsing.
READY / CLEAN	The IMPRESSA is prompting you to clean it.	▶ Perform cleaning (see Chapter 5 'Maintenance – Cleaning the machine').
READY / DE-SCALE	The IMPRESSA is prompting you to descale it.	▶ Perform descaling (see Chapter 5 'Maintenance – Descaling the machine').
READY / FILTER	After 50 litres of water have flowed through the CLARIS Blue filter cartridge, it will cease to work.	▶ Replace the CLARIS Blue filter cartridge (see Chapter 5 'Maintenance – Changing the filter').
NOT ENOUGH POWDER	There is insufficient ground coffee in the machine; the IMPRESSA stops the operation.	▶ The next time you prepare a beverage, add more ground coffee (see Chapter 2 'Preparation – Ground coffee').
TOO HOT	The system is too hot to start a maintenance programme.	▶ Wait for several minutes until the system has cooled or prepare a speciality coffee or hot water.



## 7 Troubleshooting

Problem	Cause/Result	Action
Insufficient foam is produced when the milk is frothed, or milk sprays from the dual spout.	The dual spout is dirty.	<ul style="list-style-type: none"> <li>▶ Clean the dual spout (see Chapter 5 'Maintenance – Cleaning the milk system').</li> <li>▶ Dismantle and rinse the dual spout. (see Chapter 5 'Maintenance – Dismantling and rinsing the dual spout').</li> </ul>
Coffee only comes out in drips when it is being prepared.	Coffee or ground coffee has been ground too finely and is blocking the system.	▶ Set the grinder to a coarser setting or use coarser ground coffee (see Chapter 2 'Preparation – Adjusting the grinder').
Water hardness cannot be adjusted.	The CLARIS Blue filter cartridge is activated.	▶ Deactivate the CLARIS Blue filter cartridge in programming mode.
FILL WATER TANK is displayed even though the water tank is full.	The water tank float is trapped.	▶ Descale the water tank (see Chapter 5 'Maintenance – Descaling the water tank').
Grinder is making a very loud noise.	There are foreign objects in the grinder.	▶ Contact customer support in your country (see Chapter 11 'JURA contact details / Legal information').
ERROR 2 is displayed.	If the machine was exposed to the cold for a long period of time, heating is disabled for safety reasons.	▶ Warm the machine at room temperature.
Other ERROR messages are displayed.	–	▶ Switch off the IMPRESSA with the On/Off button. ▶ Contact customer support in your country (see Chapter 11 'JURA contact details / Legal information').

**i** If you were unable to solve the problem, contact customer support in your country (see Chapter 11 'JURA contact details / Legal information').

## 8 Transport and environmentally friendly disposal

### Transport / Emptying the system

Keep the packaging for your IMPRESSA. It should be used to protect the machine during transport.

In order to protect the IMPRESSA from frost during transport, the system must be emptied.

**Precondition:** READY is displayed.

- ▶ Place a receptacle under the hot-water spout.



- ⚡ ▶ Press the Hot Water button. WATER, hot water flows out of the hot-water spout.
- ▶ Remove and empty the water tank. Hot water will continue to flow until the system is empty. FILL WATER TANK
- ⏻ ▶ Press the On/Off button to switch the machine off.

### Disposal

Please dispose of old machines in an environmentally neutral way.



Old machines contain valuable, recyclable materials which should be recycled. Please therefore dispose of old machines via suitable collection systems.

## 9 Technical data

Voltage	220–240 V ~, 50 Hz
Power	1450 W
Conformity mark	CE®
Energy consumption ECONOMY ---	approx. 10.6 Wh
Energy consumption ECONOMY ♣	approx. 4.3 Wh
Pump pressure	Static, max. 15 bar
Holding capacity of water tank (without filter)	1.1 l
Holding capacity of bean container	125 g
Holding capacity of coffee grounds container	approx. 10 servings
Cable length	approx. 1.1 m
Weight	approx. 10.9 kg
Dimensions (W × H × D)	23.9 × 32.4 × 44.5 cm

Information for testers (repeat test in accordance with DIN VDE 0701-0702): The central grounding point (CGP) is located on the underside of the machine, on the right and at the back.

## 10 Index

### A

- Addresses 59
- Aroma preservation cover
  - Bean container with aroma preservation cover 34
- Automatic switch-off 46

### B

- Bean container
  - Bean container with aroma preservation cover 34
  - Cleaning 53
  - Filling 38
- Bus bar
  - Technical data 56

### Button

- Cappuccino button 35
- Coffee button 35
- Espresso button 35
- Hot Water button 35
- Latte Macchiato button 35
- Maintenance button 35
- On/Off button 35

### C

- Cappuccino 42
- Cappuccino frother cleaning
  - Cleaning the milk system 49
- Cappuccino frother rinsing
  - Rinsing the milk system 48
- Central grounding point 56
- CLARIS Blue filter cartridge
  - Changing 51
  - Inserting and activating the filter 50
- Cleaning
  - Bean container 53
  - Machine 52
- Coffee 41
- Coffee grounds container 34
- Consistency of grind
  - Adjusting the grinder 43
  - Grinder adjustment switch 35
- Contact details 59
- Cup grille 34
- Customer support 59

### D

- Descaling
  - Machine 52
  - Water tank 53
- Display 35, 38
- Display messages 54
- Disposal 56
- Double product
  - Two speciality coffees 41
- Drip tray 34
- Dual spout
  - Dismantling and cleaning 49
  - Height-adjustable dual spout 34

### E

- Emptying the system 56
- Energy-saving mode 46
- Errors
  - Troubleshooting 55
- Espresso 41

### F

- Filling
  - Bean container 38
  - Water tank 41
- Filter
  - Changing 51
  - Inserting and activating the filter 50
- First-time use 39
  - With filter cartridge activation 39
  - Without filter cartridge activation 40

### G

- Grinder adjustment switch 35
- Ground coffee 43
  - Powder chute for ground coffee 35
- Grounding point 56

### H

- Hotline 59
- Hot water 44
- Hot-water spout 34

### I

- Instant coffee
  - Ground coffee 43
- Internet 38

## J

- JURA
  - Contact details 59
  - Internet 38

## L

- Language 48
- Latte macchiato 42

## M

- Machine
  - Cleaning 52
  - Descaling 52
  - Rinsing 48
  - Setting up 38
  - Switching off 44
  - Switching on 44
- Mains cable 34
- Maintenance 48
  - Daily maintenance 44
- Messages, display 54
- Milk system
  - Cleaning 49
  - Rinsing 48

## P

- Permanently setting the water for the cup size 42
- Permanent settings in programming mode 45
- Powder chute
  - Powder chute for ground coffee 35
- Preparation 41, 42
  - Cappuccino 42
  - Coffee 41
  - Espresso 41
  - Ground coffee 43
  - Hot water 44
  - Latte macchiato 42
  - Two speciality coffees 41
- Problems
  - Troubleshooting 55
- Programming mode 45
  - Automatic switch-off 46
  - Energy-saving mode 46
  - Language 48
  - Products 45
  - Rinses 47
  - Setting the water hardness 45
  - Unit for amount of water 47
- Proper use 36

## R

- Rinses 47
- Rinsing
  - Machine 48
- Rotary Switch 35
  - Status display 35
- Rotary Switch status display 35

## S

- Safety 36
- Safety information 36
- Settings
  - Permanent settings in programming mode 45
- Setting up
  - Setting up the machine 38
- Spout
  - Height-adjustable dual spout 34
  - Hot-water spout 34
- Switching off 44
- Switching on 44
- Switch-off
  - Automatic switch-off 46
- Symbol description 33

## T

- Technical data 56
- Tel 59
- Transport 56
- Troubleshooting 55
- Two speciality coffees 41

## U

- Unit for amount of water 47
- Use, First-time 39

## W

- Water hardness
  - Determining the water hardness 40
  - Setting the water hardness 45
- Water tank 34
  - Descaling 53
  - Filling 41
- Website 38

## 11 JURA contact details / Legal information

JURA Elektroapparate AG  
Kaffeeweltstrasse 10  
CH-4626 Niederbuchsiten  
Tel. +41 (0)62 38 98 233

@ You will find additional contact details for your country at [www.jura.com](http://www.jura.com).

### Directives

The machine complies with the following directives:

- 2006/95/EC – Low Voltage Directive
- 2004/108/EC – Electromagnetic Compatibility
- 2009/125/EC – Ecodesign Directive
- 2011/65/EU – RoHS Directive

### Technical changes

We reserve the right to make technical changes. The diagrams used in these instructions for use are for illustration purposes only and do not represent the original colours of the machine. Some details of your IMPRESSA may vary.

### Feedback

Your opinion is important to us! Use the contact link at [www.jura.com](http://www.jura.com).

### Copyright

The instructions for use contain information which is protected by copyright. It is not permitted to photocopy these instructions for use or translate them into another language without the prior written consent of JURA Elektroapparate AG.