

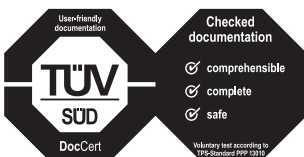

The IMPRESSA S9 One Touch Manual



The 'IMPRESSA Manual' has been awarded the seal of approval by the independent German Technical Inspection Agency, TÜV SÜD, due to its easy-to-understand style, its thoroughness and coverage of safety aspects.

Your IMPRESSA S9 One Touch

IMPORTANT SAFEGUARDS	4
Control elements	8
Proper use	10
For your safety	10
The IMPRESSA S9 One Touch Manual	13
Symbol description	14
1 IMPRESSA S9 One Touch	15
Connector System®	16
JURA on the Internet	16
Knowledge Builder	16
2 Preparing and using for the first time	17
Setting up	17
Filling the water tank	17
Bean container filling	17
First-time use	18
Using and activating filter	19
Determining and adjusting the degree of water hardness	21
Adjusting grinder	22
Switching on	23
Switching off (Standby)	24
3 Familiarising yourself with the control options	25
Preparation at the touch of a button	26
One-off settings before and during preparation	26
Entering a permanent setting for the amount of water for a cup size	27
Permanent settings in programming mode	28
Viewing information and maintenance status	31
4 Preparation at the touch of a button	32
Espresso	32
Coffee	33
Coffee à la Carte	33
Cappuccino	34
Latte macchiato	35
Pre-ground coffee	37
Hot milk and milk foam	37
Hot water	39

5	Permanent settings in programming mode	41
	Products.....	41
	Energy-saving mode (Energy Save Mode, E.S.M.®)	44
	Time and weekday.....	45
	Programmable switch-on and switch-off time.....	45
	Automatic switch-off.....	47
	Rinses	48
	Unit amount of water / time format.....	48
	Language.....	49
6	Maintenance	51
	Maintenance tips.....	51
	Rinsing the machine.....	51
	Changing the filter.....	52
	Cleaning the machine	54
	Descaling the machine.....	56
	Rinsing the cappuccino frother	58
	Cleaning the cappuccino frother.....	60
	Disassembling and rinsing the Professional Cappuccino Frother	61
	Disassembling and rinsing the Easy Cappuccino Frother.....	62
	Cleaning the bean container.....	62
	Descaling the water tank.....	63
7	Display messages	64
8	Troubleshooting	66
9	Transport and environmentally neutral disposal	68
	Transport/Emptying the system.....	68
	Disposal.....	68
10	Technical data	69
	Index	70
	JURA contact details / Legal information	72

IMPORTANT SAFEGUARDS

These safeguards apply for machines with UL safety test (see rating plate and chapter 10, 'Technical data').

Follow the basic safety precautions

When using electrical appliances, basic safety precautions should always be followed, to reduce the risk of fire, electric shock, and/or injury to persons, including the following:

- Read all instructions.
- Do not touch hot surfaces. Use handles or knobs.
- To protect against fire, electric shock and injury to persons, do not immerse cord, plugs, or body of machine in water or other liquid.
- Close supervision is necessary when any appliance is used by or near children.
- Unplug from outlet when not in use and before cleaning. Allow to cool before putting or taking off parts, and before cleaning the appliance.
- Do not operate any appliance with a damaged cord or plug or after the appliance malfunctions, or has been damaged in any manner. Return appliance to the nearest authorized service facility for examination, repair or adjustment.
- The use of accessory attachment not recommended by the appliance manufacturer may result in fire, electric shock, or injury to persons.
- Do not use outdoors.
- Do not let the cord hang over the edge of a table or counter, or touch hot surfaces.
- Do not place on or near a hot gas or electric burner, or in a heated oven.
- Always attach plug to appliance first, then plug cord into the wall outlet. To disconnect, turn any control to 'OFF' then remove plug from wall outlet.
- Do not use appliance for other than intended use.
- Use extreme caution when dispensing hot steam.
- For household use only.

SAVE THESE INSTRUCTIONS

Special cord set instructions

- a. A short power supply cord is provided to reduce the risk resulting from becoming entangled in or tripping over a long cord.
Your IMPRESSA has a 3-pin grounded plug.
 - b. Longer extension cords are available and may be used if care is exercised in their use.
 - c. If an extension cord is used,
 1. the marked electrical rating of the extension cord should be at least as great as the electrical rating of the appliance, and
 2. if the appliance is of the grounded type, the extension cord should be a grounding type 3-wire cord, and
 3. the longer cord shall be arranged so that it will not drape over the counter top or tabletop where it can be pulled on by children or tripped over.
- As a safety feature, this plug will fit in a polarized outlet only one way.
 - If the plug does not fit fully in the outlet, reverse the plug. If it still does not fit, contact a qualified electrician.
 - Do not modify the plug in any way or attempt to defeat this safety feature.

Warning

To reduce the risk of fire or electric shock, do not remove any service covers. No user serviceable parts inside. Repair should be done by authorized personnel only.

Caution

This appliance is for household use. Any servicing other than cleaning and user maintenance should be performed by an authorized service representative:

- Do not immerse base in water or try to disassemble.
- To reduce the risk of fire or electric shock, do not remove the base. No user serviceable parts inside. Repair should be done by authorized service personnel only.
- Check voltage to be sure that the voltage indicated on the name plate agrees with your voltage.
- Never use warm or hot water to fill the water container! Use cold water only.

Important Safeguards

NEVER DO (or you will void your warranty protection):

- Keep your hands and the cord away from hot parts of the appliance during operation.
- Never clean with scouring powders or hard implements.

- Never fill instant coffee, chocolate mix etc. into the grinder or ground coffee funnel (grunder by-pass). It will damage the functioning of the brewing chamber
- Never fill sugar coated coffee beans into the bean hopper. In case of doubt, call your dealer.
- Never fill anything other than coffee beans into the bean container (no chocolate, no rice, no nuts, no spices, nothing other than roasted coffee beans).
- Never do anything with the machine which is not described in the User's Manual. In case of doubt, call your dealer.

Control elements

Control elements

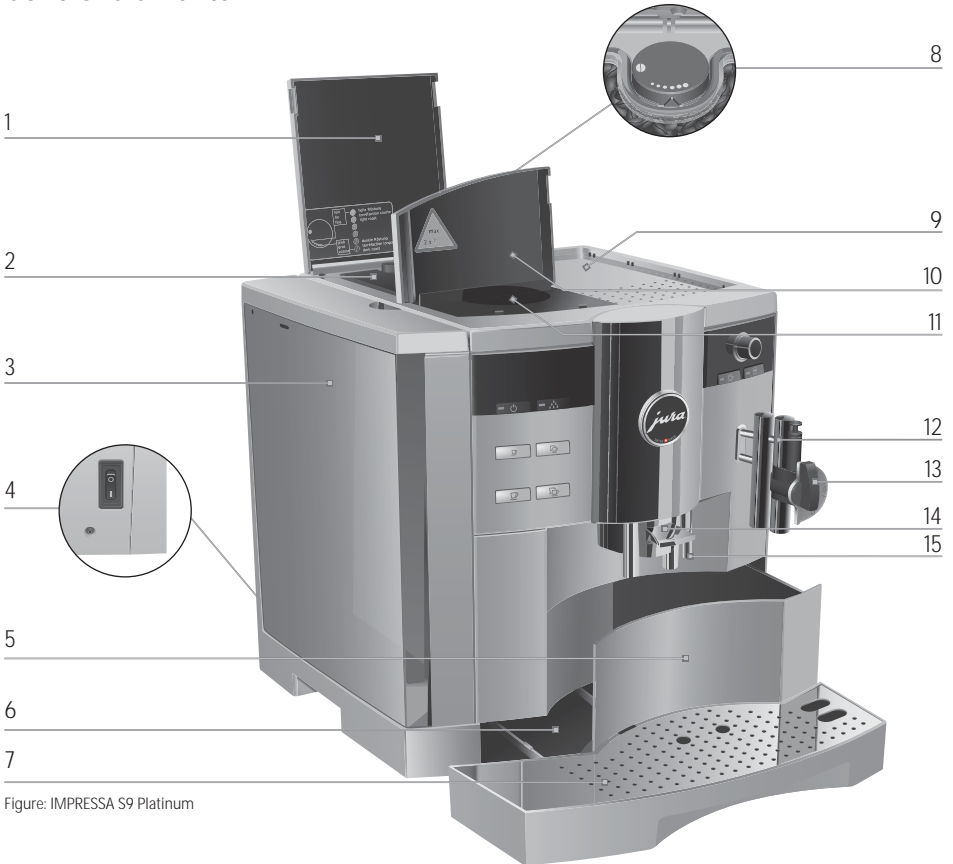











Figure: IMPRESSA S9 Platinum









- | | | | |
|---|--|----|--|
| 1 | Bean container cover | 8 | Fineness of grind switch |
| 2 | Bean container with aroma preservation cover | 9 | Cup tray |
| 3 | Water tank with handle | 10 | Cover of filler funnel for pre-ground coffee |
| 4 | Power switch and power cable (back of machine) | 11 | Filler funnel for pre-ground coffee |
| 5 | Coffee grounds container | 12 | Connector System® for removable frothers |
| 6 | Drip tray | 13 | Professional Cappuccino Frother |
| 7 | Cup platform | 14 | Height-adjustable coffee spout |
| | | 15 | Hot water spout |



Front left

- 1 Display
- 2 Rotary Switch cover
- 3  Rotary switch
-  On/off button
-  Maintenance button
-  1 Espresso button
-  2 Espresso button
-  1 Coffee button
-  2 Coffees button
-  Coffee à la Carte button
-  Pre-ground coffee button

Front right

- 4  Selector switch
- 5  Professional Cappuccino Frother
- 6  Easy Cappuccino Frother
-  Hot water portion symbol
-  Hot water symbol
-  Cappuccino button
-  Milk portion symbol
-  Milk symbol
-  Latte Macchiato button

The Connector System® permits the use of different frothers. These are available from stockists.

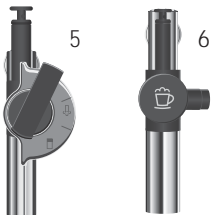

Proper use

The machine has been designed and built for domestic use. It should only be used to prepare coffee and to heat milk and water. Use for any other purpose will be deemed improper. JURA Elektroapparate AG cannot accept any responsibility for the consequences of improper use.

Before using the machine always carefully read and comply with all these instructions. Keep this manual close to the IMPRESSA and, if appropriate, pass it on to the next user.

For your safety



Please read and note carefully the following important safety information.

By doing this, you can avoid the life-threatening danger of electric shock:

- Never use a machine which has been damaged or with a defective power cable.
- For information on what to do in case of damage, for example if there is a smell of burning, unplug the machine immediately from the mains supply and contact the JURA service centre.
- If the power cable for this machine is damaged, it must be repaired either directly by JURA or by a JURA approved service centre.
- Make sure that the IMPRESSA and the power cable are not located close to hot surfaces.
- Be careful to ensure that the power cable does not get caught and does not rub against sharp edges.
- Never open and repair the machine yourself. Do not modify the machine in any way that is not described in the IMPRESSA Manual. The machine contains live parts. If opened, there is a danger of serious injury. Repairs may only be carried out by JURA approved service centres, using original spare parts and accessories.

There is a risk of scalds or burns on the spouts or in the nozzle:

- Place the machine out of the reach of children.
- Do not touch any hot parts. Use the handles provided.

- Be careful to ensure that the appropriate nozzle is installed and clean. The nozzle or parts of the nozzle might come off if the parts are not assembled correctly or a blockage occurs.

A defective machine is not safe and could cause injury or fire. To avoid damage and any associated risk of injury or fire:

- Never allow the power cable to loosely hang down. The power cable can be tripped over or damaged.
- Protect your IMPRESSA from environmental influences such as rain, frost and direct sunlight.
- Do not put the IMPRESSA, cable or connections in water.
- Do not put the IMPRESSA or any individual parts in the dishwasher.
- Turn your IMPRESSA off at the power switch before starting any cleaning operation. Always wipe your IMPRESSA with a damp cloth rather than a wet one, and protect it from prolonged water splash.
- Only connect the machine to a power supply in accordance with the information on the rating plate. The rating plate is located on the underside of your IMPRESSA. Further technical data is given in Chapter 10 'Technical Data'.
- Use only original JURA care products. Use of accessories that are not explicitly recommended by JURA could damage the IMPRESSA.
- Do not use any coffee beans treated with additives or caramelised coffee beans.
- Always fill the water tank with cold, fresh mains water.
- If you will be absent for an extended period, turn the machine off and unplug.

Risk to children and persons with limited capabilities in operating machines:

- The machine is not designed to be operated by children and persons with limited capabilities.
- The machine may only be used by persons who are able to operate the machine safely.

Important information

Safe handling of the CLARIS filter cartridges:

- Filter cartridges should be kept out of the reach of children.
- Store them dry in the sealed package.
- Protect them from heat and direct sunlight.
- Do NOT use damaged filter cartridges.
- Do NOT open filter cartridges.

The IMPRESSA S9 One Touch Manual

You are holding the manual for your IMPRESSA S9 One Touch in your hand. It will help you to familiarize yourself with your IMPRESSA safely and quickly and teach you the full range of facilities it offers.

Chapter 2, 'Preparing and using your IMPRESSA for the first time', explains step-by-step how to set up and prepare the IMPRESSA.

Chapter 3, 'Familiarising yourself with the control options' is important for you to read as you are familiarising yourself with your IMPRESSA. It invites you to actively explore all the different coffee experiences that it offers.

All the other chapters are intended to help you when you have a specific query.

If you use the IMPRESSA S9 One Touch Manual, you will become a master at preparing exciting coffee specialities, you will be a Barista!

You can download the short operating instructions for your machine from the JURA website (www.jura.com).

Symbol description

Warnings

 CAUTION	Always take note of any information marked with the CAUTION or WARNING symbol. The signal word WARNING points out potential risk of serious injury, and the signal word CAUTION potential risk of slight injury.
CAUTION	The CAUTION symbol is used to draw attention to circumstances which could cause the machine to become damaged.

Symbols used

i	Information and tips to make things easier for you as you use your IMPRESSA.
@	References to the online JURA website, where you can find interesting further information: www.jura.com .
▶	Prompt to take action. This symbol means that you are being prompted to perform some action.

1 IMPRESSA S9 One Touch

Coffee that fulfils your wildest dreams

With the new flagship of the IMPRESSA S range, cappuccino and latte macchiato are prepared at the touch of a button without you having to move the cup. With its elegant platinum styling and upgraded design, this high-quality product is fully in keeping with contemporary trends and exudes superiority, solidity and competence. It impressively demonstrates these attributes with each coffee speciality that you enjoy.



- **One Touch Cappuccino/Latte Macchiato:** Your IMPRESSA S9 makes a cup of cappuccino at the touch of a button, without you having to move the cup. Hot milk foam, flowing into the cup and slowly starting to fill it. Steam which rises, awakening the anticipation of a delicious speciality. Aromatic coffee, blending with the milk, pushing up the milk foam topping. These are the protagonists in a sensuous drama – the drama of perfect coffee preparation. A latte macchiato can also be made equally easily and sensuously at the touch of a button.

- **Energy-saving mode (Energy Save Mode, E.S.M.®):** The IMPRESSA S9 One Touch actively assists you in saving energy. With the various stages of the energy-saving mode, you can adjust the energy saving potential to suit the way you like to enjoy your beverages. The machine can be completely disconnected from the power supply at the main switch – for instance if you are going to be absent for some time.

- **Control philosophy:** You can 'navigate' reliably through all operating and programming steps simply by turning and pressing the switch. The information on the plain text and graphic display is in full view at all times. The focus is on your personal taste. Simply select the coffee strength, amount of water and temperature according to your individual preferences.



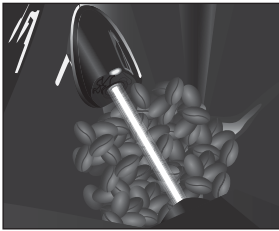

- **Professional technology for the home:** The active bean monitoring feature of your IMPRESSA S9 banishes the sound of empty rotating coffee grinders and the inconvenience of half-full cups once and for all. It always shows you in good time when the coffee beans need replenishing. The filling level of the 280 gram bean container is continuously optically monitored.

Connector System®

The Connector System® permits the use of different cappuccino frothers:

- Professional Cappuccino Frother
 - Cappuccino/latte macchiato
 - Hot milk
- Easy Cappuccino Frother
 - Cappuccino/latte macchiato

JURA on the Internet

Visit us on the Internet.

- @ At www.jura.com you will find interesting and up-to-date information on your IMPRESSA and on every aspect of coffee.

Knowledge Builder

You can familiarize yourself with your IMPRESSA S9 in a fun way on the PC.

- @ The Knowledge Builder awaits you at www.jura.com. The interactive assistant, LEO, will support you and explain the benefits of and how to use your IMPRESSA.

2 Preparing and using for the first time

This chapter provides you with the information you need to use your IMPRESSA without any problems. You will prepare your IMPRESSA step-by-step for your first coffee experience.

Setting up

When setting up your IMPRESSA, please note the following:

- Set the IMPRESSA down on a horizontal surface that is not sensitive to water.
- Choose a spot for your IMPRESSA which is protected against overheating.

Filling the water tank

To enjoy perfect coffee we recommend changing the the water every day.

CAUTION

Milk, mineral water or other liquids can damage the water tank or the machine.

- ▶ Only fill the water tank with fresh, cold water.
-
- ▶ Remove the water tank and rinse it with cold water.
 - ▶ Fill the water tank with fresh, cold water and reinsert.

Bean container filling

The bean container has an aroma preservation cover. This will ensure that your coffee beans retain their aroma for longer.

CAUTION

Coffee beans which have been treated with additives (e.g. sugar), pre-ground or freeze-dried coffee will damage the grinder.

- ▶ Only use untreated coffee beans to refill the bean container.
-
- ▶ Open the cover of the bean container and remove the aroma preservation cover.
 - ▶ Remove any dirt or foreign objects inside the bean container.
 - ▶ Fill the bean container with coffee beans, then close the aroma preservation cover and the bean container cover.

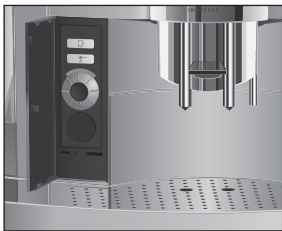

First-time use



If the machine is operated with a defective power cable, there is a danger of electric shock.

- ▶ Never use a machine which has a defective power cable.

Precondition: The water tank and bean container are full.

- ▶ Insert the mains plug into a power socket.
- ▶ Switch on the IMPRESSA using the power switch on the back of the machine.
The on/off button  lights up (standby).
- ▶ Press the on/off button to switch the IMPRESSA on.
The pre-set language appears on the display.
- ▶ Open the cover of the Rotary Switch.
- ▶ Turn the Rotary Switch until the desired language is displayed. For Example: **LANGUAGE ENGLISH**
- ▶ Press the Rotary Switch to confirm the language.
CONFIRMED ✓ appears briefly on the display to confirm the setting.
TIME ---:--
- ▶ Turn the Rotary Switch to set the hour.
TIME 12:00 (Example)
- ▶ Press the Rotary Switch to confirm the hour setting.
TIME 12:00
- ▶ Turn the Rotary Switch to set the minutes.
TIME 12:45 (Example)
- ▶ Press the Rotary Switch to confirm the minute setting.
CONFIRMED ✓ appears briefly on the display.
WEEKDAY MONDAY
- ▶ Turn the Rotary Switch to set the weekday.
WEEKDAY WEDNESDAY (Example)
- ▶ Press the Rotary Switch to confirm the setting.
CONFIRMED ✓ appears briefly on the display.
FILL SYSTEM / PRESS RINSE, the maintenance button  lights up.



- ▶ Place a receptacle under the hot water spout and another under the frother.
- ⚡ ▶ Press the maintenance button.
SYSTEM FILLS, the system fills up with water and the maintenance button flashes. A small amount of water flows from the frother and the hot water spout. This operation stops automatically. **WELCOME TO JURA** appears on the display.
HEATING UP
PRESS RINSE, the maintenance button ⚡ lights up.
- ▶ Place a receptacle under the coffee spout.
- ⚡ ▶ Press the maintenance button.
The machine rinses itself, stopping automatically. **COFFEE READY** appears on the display. Your IMPRESSA is ready to use.

- i** After first-time use do not disconnect the IMPRESSA from the power supply for 24 hours to ensure that it is in the optimum operating condition.
- i** When a coffee speciality has been prepared for the first time, it is possible that **FILL BEANS** is shown on the display as the grinder has not yet been completely filled with coffee beans. In this case prepare a different coffee speciality.
- i** If you have not been able to use the machine for the first time correctly and fully, contact Customer Support in your country (see 'JURA contact details / Legal information').

Using and activating filter

Your IMPRESSA no longer has to be descaled if you are using CLARIS filter cartridges.

- @ You can also try out the 'Insert filter' operation online. Visit the Knowledge Builder at www.jura.com.
- i** Perform the 'Insert filter' operation without interruptions. This will ensure that your IMPRESSA always produces its best.

Precondition: **COFFEE READY** is displayed.

- ▶ Open the cover of the Rotary Switch.
- ⏻ ▶ Keep the Rotary Switch pressed **until MAINTENANCE** appears on the display.
- ⌚ ▶ Turn the Rotary Switch until **FILTER NO** is displayed.
- ⏻ ▶ Press the Rotary Switch to enter the programme item.
FILTER NO
- ⌚ ▶ Turn the Rotary Switch until **FILTER YES** is displayed.
- ⏻ ▶ Press the Rotary Switch to confirm the setting.
CONFIRMED ✓ appears briefly on the display to confirm the setting.
INSERT FILTER / PRESS RINSE, the maintenance button **⚡** lights up.
- ▶ Remove a CLARIS filter cartridge and the filter cartridge extension from the Welcome Pack.
- ▶ Fit the extension on top of the filter cartridge.
- ▶ Remove the water tank and empty it.
- ▶ Lift the cartridge holder and insert the filter cartridge into the water tank, applying slight pressure.
- ▶ Close the cartridge holder. It will click into place audibly.
- ▶ Fill the water tank with fresh, cold water and reinsert.



- ▶ Place a receptacle (at least 500 ml) under the frother.

i If you are using the **Professional Cappuccino Frother**, set the selection lever of the frother to the steam position **☷**.

- ⚡** ▶ Press the maintenance button.
FILTER RINSING, water flows out of the frother.

i You can interrupt rinsing of the filter at any time by pressing any button.

i The water may be slightly discoloured. This is not harmful to health and does not affect the taste.

Filter rinsing stops automatically after approx. 500 ml. **COFFEE READY** appears on the display. The filter is now activated.

Determining and adjusting the degree of water hardness

The harder the water is, the more frequently the IMPRESSA needs to be descaled. It is therefore important to adjust the water hardness.

The water hardness can be adjusted on a continuous scale between 1° dH and 30° dH. This can also be deactivated, which means that the IMPRESSA will not let you know when it has to be descaled.

- i** However, if you are using the CLARIS filter cartridge and have activated it, you will not be able to adjust the water hardness.





You can find out what the water hardness is by using the Aquadur® test strip supplied as standard.

- ▶ Hold the test strip briefly (for one second) under flowing water. Shake off the water.
- ▶ Wait for about one minute.
- ▶ You will then be able to read the degree of water hardness from the discolouration of the Aquadur® test strip and the description on the packaging.

You can now adjust the water hardness.

Example: To change the water hardness from **16°dH** to **25°dH**, proceed as follows:

Precondition: **COFFEE READY** is displayed.

- ▶ Open the cover of the Rotary Switch.
-  ▶ Keep the Rotary Switch pressed **until** **MAINTENANCE** appears.
-  ▶ Turn the rotary switch until **HARDNESS 16°dH** is displayed.
-  ▶ Press the Rotary Switch to enter the programme item. **MF°dH**
-  ▶ Turn the Rotary Switch until **25°dH** is displayed.

- ▶ Press the Rotary Switch to confirm the setting.
CONFIRMED ✓ appears briefly on the display.
HARDNESS 25° dH
- ▶ Turn the Rotary Switch until **EXIT** is displayed.
- ▶ Press the Rotary Switch to exit programming mode.
COFFEE READY is shown on the display.

Adjusting grinder

You can adjust the grinder continuously to suit the roast of your coffee.

CAUTION

If you adjust the fineness of grind when the grinder is not operating, the grinding wheel could be damaged.

- ▶ Only adjust the fineness of grind when the grinder is running.

The fineness of grind setting is correct if the coffee flows regularly from the coffee spout. A fine, thick crema is also formed.

Our recommendations:

- Select a fine setting for a light roast.
 - If the fineness of grind setting is **too fine**, the coffee only drips from the coffee spout.
- Select a coarse setting for a darker roast.
 - If the fineness of grind is **too coarse** the coffee flows too quickly from the coffee spout.

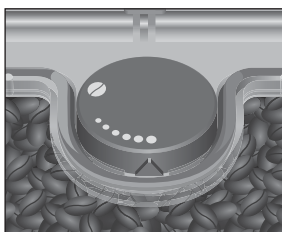
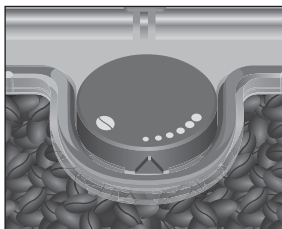

Example: To change the fineness of grind **during** coffee preparation, proceed as follows:

- ▶ Open the cover of the bean container.
- ▶ Place a cup under the coffee spout.
- ▶ Press the 1 Coffee button.
The grinder starts and **1 COFFEE** is displayed.

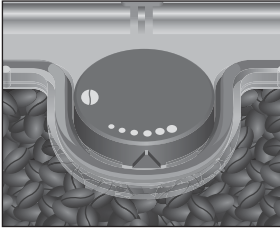





- ▶ Turn the fineness of grind switch to the desired position **while** the grinder is running. The coffee will be prepared and the fineness of grind is adjusted.

Switching on

When the IMPRESSA is switched on, a prompt for the rinse operation automatically appears which is initiated by pressing the maintenance button.

This setting can be changed in programming mode so that the machine automatically activates the switch-on rinse (see Chapter 5 'Permanent settings in programming mode – Rinses').

Precondition: Your IMPRESSA is switched on at the power switch and the on/off button  is illuminated (standby).

-  ▶ Press the on/off button to switch the IMPRESSA on.
 - WELCOME TO JURA** appears briefly on the display.
 - HEATING UP**
 - PRESS RINSE**, the maintenance button  lights up.
- ▶ Place a receptacle under the coffee spout.
-  ▶ Press the maintenance button.
 - The machine rinses itself, stopping automatically.
 - COFFEE READY** appears on the display. Your IMPRESSA is ready to use.



Switching off (Standby)

When you switch your IMPRESSA off, the spouts with which a coffee speciality or milk have been prepared are rinsed.



- ▶ Place a receptacle under the coffee spout and the frother.
 - ⏻ ▶ Press the on/off button.
`MACHINE RINSING` appears on the display, and the coffee spout is rinsed.
`SPOUT RIGHT / PRESS RINSE.`
 - ⚡ ▶ Press the maintenance button.
`MACHINE RINSING`, the right coffee spout is rinsed.
- i** When you prepare a milk product, but have not performed cappuccino cleaning, `CLEAN CAPPUCCINO` appears and the maintenance button ⚡ lights up. For ten seconds you can start the 'Clean cappuccino frother' procedure by pressing the maintenance button ⚡.

The IMPRESSA is switched off (standby mode), and the on/off button ⏻ lights up.

- i** When your IMPRESSA is switched off, a hissing noise may be audible. This is normal and does not have any effect on the machine.

3 Familiarising yourself with the control options

With the IMPRESSA, you can prepare an excellent coffee or milk speciality at the touch of a button. You also have the option of adjusting the coffee strength and temperature, as well as the amount of water to your personal taste.

This chapter will allow you to become familiar with all control options with the aid of examples. To familiarise yourself with your IMPRESSA, we recommend that you make a point of actively trying the facilities described in this chapter. You will find this is well worthwhile.

Learn how to perform the following:

- Preparation at the touch of a button
- One-off settings **before** and **while** your drink is being prepared
- Adjusting the default amount of water to suit the cup size
- Permanent settings in programming mode

i You can stop the machine at any time while a coffee or milk speciality or hot water is being prepared. To do this, press any button.

@ If you prefer to familiarise yourself with your IMPRESSA in a fun way on the computer, the interactive Knowledge Builder tutorial programme can be found on the Internet at www.jura.com.

Preparation at the touch of a button



Prepare your favourite coffee speciality at the touch of a button.

All coffee specialities are prepared following this model.

Example: This is how to prepare **one** coffee.

Precondition: COFFEE READY is displayed.

- ▶ Place a cup under the coffee spout.
- ☞ ▶ Press the 1 Coffee button.
1 COFFEE and the pre-set coffee strength is displayed.
The pre-set amount of water flows into the cup. Preparation stops automatically. ENJOY appears on the display. COFFEE READY is then displayed.

i To prepare **2 coffees**, place two cups under the coffee spout and press the 2 Coffees button ☞.

One-off settings before and during preparation

It is possible to make various settings before and during preparation. These one-off settings are always follow the same model and are not stored.

Changing the coffee strength before preparation

The **coffee strength** of **Coffee à la Carte** can be changed before preparation. The following coffee strength options can be selected:

- ☞ (xmild)
- ☞☞ (mild)
- ☞☞☞ (normal)
- ☞☞☞☞ (strong)
- ☞☞☞☞☞ (xstrong)

Example: Proceed as follows to to prepare a **strong** cup of Coffee à la Carte.

Precondition: COFFEE READY is displayed.

- ▶ Place a cup under the coffee spout.
- ▶ Open the cover of the Rotary Switch.
- ☞ ▶ Press the Coffee à la Carte button.
A LA CARTE and the pre-set coffee strength is displayed.
- ☞ ▶ Turn the Rotary Switch until A LA CARTE ☞☞☞☞ is displayed.



- ▶ Turn the Rotary Switch **while** **A LA CARTE** **0000** is displayed.
A LA CARTE **0000**, the pre-set amount of water flows into the cup. Preparation stops automatically. **ENJOY** appears on the display. **COFFEE READY** is then displayed.

Changing the amount of water during preparation

The pre-set **amount of water** of all coffee products can be changed during the brewing operation by turning the Rotary Switch.

Example: Proceed as follows to prepare a **110 ML** cup of coffee.

Precondition: **COFFEE READY** is displayed.

- ▶ Place a cup under the coffee spout.
- ▶ Open the cover of the Rotary Switch.
- ▶ Press the 1 Coffee button.
1 COFFEE and the pre-set coffee strength is displayed. The brewing operation starts and the coffee flows into the cup.
- ▶ Turn the Rotary Switch **during** the brewing operation until **1 COFFEE / 110 ML** is displayed. The set amount of water flows into the cup. Preparation stops automatically. **ENJOY** appears on the display. **COFFEE READY** is then displayed.



Entering a permanent setting for the amount of water for a cup size

It is easy to make permanent settings for the amount of water for all coffee specialities, cappuccino, latte macchiato, a portion of hot water and portion of milk according to the cup size. As in the following example, adjust the amount of water once. Every time you prepare a drink in the future, this amount of water will be dispensed.

Making the permanent settings for the amount of water for the respective cup size always follows this model.

Example: To make **permanent** settings for the amount of water for an espresso, proceed as follows:

Precondition: **COFFEE READY** is displayed.



- ▶ Place an espresso cup under the coffee spout.
- ☞ ▶ Press and **hold** the 1 Espresso button.
1 ESPRESSO and the coffee strength is displayed.
- ☞ ▶ **Hold** the Espresso button **down** until **ENOUGH COFFEE?** appears.
- ☞ ▶ **Release** the 1 Espresso button.
Coffee preparation will start and the espresso will flow into the cup.
- ▶ Press any button as soon as enough espresso has flowed into the cup.
Preparation stops automatically. **CONFIRMED ✓** appears briefly on the display. The set amount of water for an espresso will be permanently stored. **COFFEE READY** is then displayed.

i You can alter these settings at any time by repeating the above procedure.

Permanent settings in programming mode

You can easily adjust your IMPRESSA to your personal coffee blends and specialities. You can navigate through the easy-to-understand programme steps and make permanent settings simply by turning and pressing the Rotary Switch.

You can make the following permanent settings with the Rotary Switch:

Programme item	Subitem	Explanation
MAINTENANCE	CLEAN CAPPUCCINO, RINSE MACHINE, RINSE CAPPUCCINO, CLEAN MACHINE, DECALCIFY MACHINE, CHANGE FILTER	▶ Select the desired maintenance programme. If no action is taken, programming mode is exited in the MAINTENANCE programme item automatically after approx. five seconds.

Programme item	Subitem	Explanation
PRODUCTS		▶ Select your settings for the coffee and milk specialities and hot water.
FILTER	FILTER YES FILTER NO	▶ Indicate whether you operate your IMPRESSA with or without a CLARIS filter cartridge.
HARDNESS (is only displayed when the filter is not activated)	HARDNESS INACTIVE, 1 °dH – 30 °dH	▶ Adjust the water hardness.
ECONOMY MODE	SAVE NO, SAVE LEVEL 1, SAVE LEVEL 2	▶ Select an energy-saving mode.
TIME	--!--, WEEKDAY	▶ Set the time and weekday.
UNIT ON/OFF		▶ Set the switch-on and switch-off time individually for each weekday.
OFF AFTER	OFF AFTER -- H, 0.5 H – 15 H	▶ Set the number of hours after which the IMPRESSA should switch off automatically.
RINSES	INIT RINSE, CAPP RINSE	▶ Set whether the switch-on rinse should be started manually or automatically. ▶ Set whether the prompt for cappuccino rinsing should be started immediately or 10 minutes after preparation of a milk speciality.
INFORMATION		▶ Keep track of all prepared coffee and milk specialities and view the maintenance status.
SETTINGS	ML/OZ, 24HRS/AM PM	▶ Select the unit of the amount of water and the time format.
LANGUAGE		▶ Select the desired language.
EXIT		▶ Exit programming mode.

Settings in programming mode always follow the same model.

Example: To change the strength of one espresso from ☺☺☺ (normal) to ☺☺☺☺ (strong).

Precondition: COFFEE READY is displayed.

- ▶ Open the cover of the Rotary Switch.
- ⏻ ▶ Keep the Rotary Switch pressed until MAINTENANCE appears.
- ⌚ ▶ Turn the Rotary Switch until PRODUCTS is displayed.
- ⏻ ▶ Press the Rotary Switch to enter the programme item.
SELECT PRODUCT

i Next select the product button for which you would like to make settings. No product is prepared during this procedure.





- ☑ ▶ Press the 1 Espresso button.
WATER 45 ML
- ⌚ ▶ Turn the Rotary Switch until AROMA ☺☺☺ is displayed.
- ⏻ ▶ Press the Rotary Switch to enter the programme item.
NORMAL ☺☺☺
- ⌚ ▶ Turn the Rotary Switch until STRONG ☺☺☺☺ is displayed.
- ⏻ ▶ Press the Rotary Switch to confirm the setting.
CONFIRMED ✓ appears briefly on the display.
AROMA ☺☺☺☺
- ⌚ ▶ Turn the Rotary Switch until EXIT is displayed.
- ⏻ ▶ Press the Rotary Switch to exit the programme item.
SELECT PRODUCT
- ⌚ ▶ Turn the Rotary Switch until EXIT is displayed.
- ⏻ ▶ Press the Rotary Switch to exit the programme item.
PRODUCTS
- ⌚ ▶ Turn the Rotary Switch until EXIT is displayed.
- ⏻ ▶ Press the Rotary Switch to exit programming mode.
COFFEE READY

Viewing information and maintenance status



Under the programme item **INFORMATION** you can query the following information:

- Number of the prepared coffee and milk specialities and hot water
- Maintenance status and number of maintenance programmes performed (cleaning, descaling, filter change)
- Number of performed cappuccino cleaning operations

Precondition: **COFFEE READY** is displayed.

- ▶ Open the cover of the Rotary Switch.
-  ▶ Press the Rotary Switch **until MAINTENANCE** appears.
-  ▶ Turn the Rotary Switch until **INFORMATION** is displayed.
-  ▶ Press the Rotary Switch to enter the programme item. **TOTAL**, the sum of all prepared coffee and milk specialities is displayed.
-  ▶ Turn the Rotary Switch for further information.

i The respective maintenance status can also be displayed in addition to the number of performed maintenance programmes. The bar shows the current maintenance status. When the bar is filled completely, your IMPRESSA will request the respective maintenance programme.

-  ▶ Press the Rotary Switch to exit the programme item. **INFORMATION**
-  ▶ Turn the Rotary Switch until **EXIT** is displayed.
-  ▶ Press the Rotary Switch to exit programming mode. **COFFEE READY**

4 Preparation at the touch of a button

In this chapter you will find out how to prepare coffee and milk specialities and hot water without making further settings.

Chapter 3, 'Familiarising yourself with the control options', will teach you how to adjust the settings to your personal preferences. Alternatively, you can use Chapter 5, 'Permanent settings in programming mode'.

- i** You can stop the machine at any time while a coffee or milk product or hot water is being prepared. To do this, press any button.
- i** During preparation, you can change the pre-set amount of water by turning the Rotary Switch.
- @** You can also try out the preparation of coffee specialities on-line. Visit the Knowledge Builder at www.jura.com.

Espresso

The classic coffee drink from Italy. There is a definite crema on the surface of the espresso.

Example: This is how to prepare **one** espresso.

Precondition: **COFFEE READY** is displayed.

- ▶ Place an espresso cup under the coffee spout.
- ▶ Press the 1 Espresso button.

1 ESPRESSO and the pre-set coffee strength are displayed.

The pre-set amount of water flows into the cup. Preparation stops automatically. **ENJOY** appears on the display.

COFFEE READY is then displayed.

- i** To prepare **two espressi** place two cups under the coffee spout and press the 2 Espresso button .



Coffee



Example: This is how to prepare **one** coffee.

Precondition: **COFFEE READY** is displayed.

- ▶ Place a coffee cup under the coffee spout.
- ☞ ▶ Press the 1 Coffee button.
1 COFFEE and the pre-set coffee strength are displayed.
 The pre-set amount of water flows into the cup. Preparation stops automatically. **ENJOY** appears on the display.
COFFEE READY is then displayed.

i To prepare **2 coffees**, place two cups under the coffee spout and press the 2 Coffees button ☞.

Coffee à la Carte

The **coffee strength** of Coffee à la Carte can be changed **before** preparation.

Example: Proceed as follows to prepare a **strong** (☞☞☞☞) cup of Coffee à la Carte.

Precondition: **COFFEE READY** is displayed.

- ▶ Place a cup under the coffee spout.
- ▶ Open the cover of the Rotary Switch.
- ☞ ▶ Press the Coffee à la Carte button.
A LA CARTE ☞
- ☞ ▶ Turn the Rotary Switch until **A LA CARTE ☞☞☞☞** is displayed.
- ☞ ▶ Press the Rotary Switch **while** **A LA CARTE ☞☞☞☞** is displayed.
A LA CARTE ☞☞☞☞, the pre-set amount of water flows into the cup. Preparation stops automatically. **ENJOY** appears on the display. **COFFEE READY** is then displayed.



Cappuccino



Your IMPRESSA prepares a cappuccino at the touch of a button. It is not necessary to move the cup.

Cappuccino with the Professional Cappuccino Frother



Precondition: **COFFEE READY** is displayed.

- ▶ Take the protective cover off the Professional Cappuccino Frother.
- ▶ Attach the milk pipe to the frother. For a milk carton/bottle use the long pipe, for a milk container the short pipe.
- ▶ Insert the other end into a milk carton/bottle or connect it to the milk container.

- ▶ Place a cup under the frother.
- ▶ Turn the selection lever of the frother to the milk foam position .
- ▶ Press the Cappuccino button.  **CAPPUCINO** and the coffee strength are displayed. The milk foam is then prepared. The operation stops automatically when the pre-set amount of milk is reached. Coffee preparation then begins. The pre-set amount of water flows into the cup. Preparation stops automatically. **ENJOY** appears on the display. **COFFEE READY** is then displayed.

To ensure that the frother works perfectly, you should rinse and clean it regularly. The description for this can be found in Chapter 6 'Maintenance – Cappuccino frother'.

Cappuccino with the Easy Cappuccino Frother

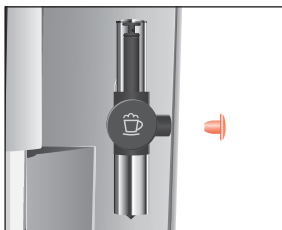

Precondition: **COFFEE READY** is displayed.

- ▶ Take the protective cover off the Easy Cappuccino Frother.
- ▶ Attach the milk pipe to the frother. For a milk carton/bottle use the long pipe, for a milk container the short pipe.
- ▶ Insert the other end into a milk carton/bottle or connect it to the milk container.



- ▶ Place a cup under the frother.
- ▶ Press the Cappuccino button.  **CAPPUCINO** and the coffee strength are displayed. The milk foam is then prepared. The operation stops automatically when the pre-set amount of milk is reached. Coffee preparation then begins. The pre-set amount of water flows into the cup. Preparation stops automatically. **ENJOY** appears on the display. **COFFEE READY** is then displayed.

To ensure that the frother works perfectly, you should rinse and clean it regularly. The description for this can be found in Chapter 6 'Maintenance – Cappuccino frother'.



Latte macchiato

Your IMPRESSA prepares a latte macchiato at the touch of the button. It is not necessary to move the glass.

Latte macchiato with the Professional Cappuccino Frother

Precondition: **COFFEE READY** is displayed.



- ▶ Take the protective cover off the Professional Cappuccino Frother.
- ▶ Attach the milk pipe to the frother. For a milk carton/bottle use the long pipe, for a milk container the short pipe.
- ▶ Insert the other end into a milk carton/bottle or connect it to the milk container.
- ▶ Place a glass under the frother.
- ▶ Turn the selection lever of the frother to the milk foam position .
- ▶ Press the Latte Macchiato button.  **LATTE MAC.** and the coffee strength are displayed. The milk foam is then prepared. The operation stops automatically when pre-set amount of milk is reached.

- i** A brief pause follows during which the hot milk separates from the milk foam. This enables the formation of the typical layers of a latte macchiato. The duration of this pause can be defined in programming mode.

Coffee preparation then begins. The pre-set amount of water flows into the glass. Preparation stops automatically. **ENJOY** appears on the display. **COFFEE READY** is then displayed.

To ensure that the frother works perfectly, you should rinse and clean it regularly. The description for this can be found in Chapter 6 'Maintenance – Cappuccino frother'.

Latte macchiato with the Easy Cappuccino Frother

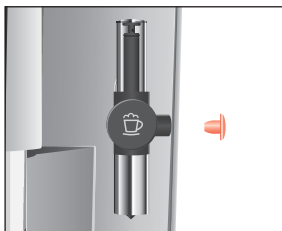

Precondition: **COFFEE READY** is displayed.

- ▶ Take the protective cover off the Easy Cappuccino Frother.
- ▶ Attach the milk pipe to the frother. For a milk carton/bottle use the long pipe, for a milk container the short pipe.
- ▶ Insert the other end into a milk carton/bottle or connect it to the milk container.
- ▶ Place a glass under the frother.
-  ▶ Press the Latte Macchiato button. **LATTE MAC.** and the coffee strength are displayed. The milk foam is then prepared. The operation stops automatically when pre-set amount of milk is reached.
- i** A brief interval follows during which the hot milk separates from the milk foam. This enables the formation of the typical layers of a latte macchiato. The duration of this interval can be defined in programming mode.

Coffee preparation then begins. The pre-set amount of water flows into the glass. Preparation stops automatically. **ENJOY** appears on the display. **COFFEE READY** is then displayed.

To ensure that the frother works perfectly, you should rinse and clean it regularly. The description for this can be found in Chapter 6 'Maintenance – Cappuccino frother'.

Pre-ground coffee

You can choose a second coffee blend, for example decaffeinated coffee, with the filler funnel for pre-ground coffee.

- i** Never add more than two level measuring spoons of pre-ground coffee.
- i** Use pre-ground coffee which is not ground too finely. Very fine coffee can block up the system so that the coffee only comes out in drips.
- i** If you did not fill the machine with a sufficient amount of pre-ground coffee, **NOT ENOUGH PRE-GROUND** is displayed and the IMPRESSA stops operation.

All coffee specialities with pre-ground coffee are prepared following this model.

Example: This is how to prepare a cup of coffee using pre-ground coffee.

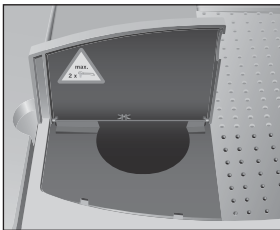

- ▶ Place a cup under the coffee spout.
- ▶ Open the cover of the filler funnel for pre-ground coffee.
- ▶ Open the cover of the Rotary Switch.
- ☞** ▶ Press the Pre-ground coffee button.
FILL PRE-GROUND / COFFEE READY
- ▶ Place one level measuring spoon of pre-ground coffee into the filler funnel.
- ▶ Close the cover of the filler funnel for pre-ground coffee.
- ☞** ▶ Press the 1 Coffee button.
1 COFFEE, the pre-set amount of water flows into the cup. Preparation stops automatically. **ENJOY** appears on the display. **COFFEE READY** is then displayed.

Hot milk and milk foam

There are two options for preparing hot milk or milk foam:

- Milk portion **☞**
- The preset quantity of milk is then prepared.

- Milk ☞
 - Milk is prepared until preparation is interrupted by pressing any button.

Foaming and heating milk with the Professional Cappuccino Frother

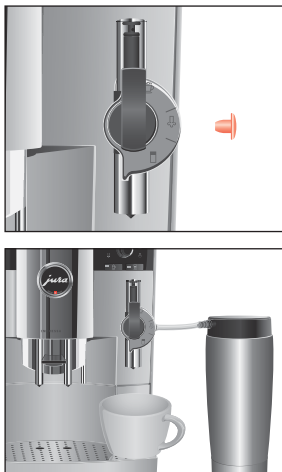

Precondition: COFFEE READY is displayed.

- ▶ Take the protective cover off the frother.
- ▶ Attach the milk pipe to the frother. For a milk carton/bottle use the long pipe, for a milk container the short pipe.
- ▶ Insert the other end into a milk carton/bottle or connect it to the milk container.

- ▶ Place a cup under the frother.
- ▶ Turn the selection lever of the frother to the milk foam position ☞.

i If you want to **heat the milk**, set the selection lever of the frother to the milk position ☞.

☞ ▶ With the selector switch select the milk portion symbol ☞.

☞ ▶ Press the selector switch.

MILK, the milk foam is being prepared. Preparation stops automatically when the pre-set amount of milk is reached. COFFEE READY is shown on the display.

To ensure that the frother works perfectly, you should rinse and clean it regularly. The description for this can be found in Chapter 6 'Maintenance – Cappuccino frother'.

Foaming milk with the Easy Cappuccino Frother

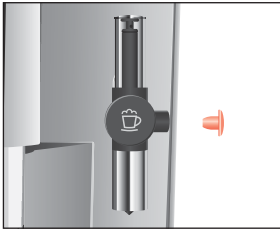

Precondition: COFFEE READY is displayed.



- ▶ Take the protective cover off the frother.
- ▶ Attach the milk pipe to the frother. For a milk carton/bottle use the long pipe, for a milk container the short pipe.
- ▶ Insert the other end into a milk carton/bottle or connect it to the milk container.

- ▶ Place a cup under the frother.
 - ▶ With the selector switch select the milk portion symbol .
 - ▶ Press the selector switch.
- MILK, the milk foam is being prepared. Preparation stops automatically when the pre-set amount of milk is reached.
- COFFEE READY is shown on the display.

To ensure that the frother works perfectly, you should rinse and clean it regularly. The description for this can be found in Chapter 6 'Maintenance – Cappuccino frother'.

Hot water

Hot water can be prepared in two ways:

- Hot water portion 
 - The pre-set amount of water flows into the cup.
- Hot water 
 - Water flows out of the hot water spout until preparation is interrupted by pressing any button.

The following temperatures can be selected for preparing hot water:

- Low
- Normal
- X high



There is a danger of scalding from hot water splashes.

- ▶ Avoid direct contact with the skin.

4 Preparation at the touch of a button



Example: This is how to prepare a **portion** of hot water.

Precondition: **COFFEE READY** is displayed.

- ▶ Place a cup under the hot water spout.
- ▶ Use the selector switch to select the hot water portion symbol .
- ▶ Press the selector switch.
TEMPERATURE and the pre-set temperature are displayed.

i By pressing the selector switch several times (**within approx. 2 seconds**) you can set the temperature to your individual preference. This setting is not saved.

HOT WATER, the pre-set amount of water flows into the cup. Preparation stops automatically. **COFFEE READY** appears on the display.

5 Permanent settings in programming mode

Products

With the **PRODUCTS** programme item you can enter individual settings for all coffee and milk specialities as well as hot water.

The following permanent settings can be made:

Product	Amount	Coffee strength	Temp.
1 Espresso	25 ML – 240 ML	☉ (xmild), ☉☉ (mild), ☉☉☉ (normal), ☉☉☉☉ (strong), ☉☉☉☉☉ (xstrong)	NORMAL, HIGH
2 Espresso	25 ML – 240 ML (per cup)	–	NORMAL, HIGH
1 Coffee	25 ML – 240 ML	☉ (xmild), ☉☉ (mild), ☉☉☉ (normal), ☉☉☉☉ (strong), ☉☉☉☉☉ (xstrong)	NORMAL, HIGH
2 Coffees	25 ML – 240 ML (per cup)	–	NORMAL, HIGH
Coffee à la Carte	25 ML – 240 ML	–	NORMAL, HIGH
Cappuccino	Amount of milk: 3 SEC – 120 SEC Pause: 0 SEC – 60 SEC Amount of water: 25 ML – 240 ML	☉ (xmild), ☉☉ (mild), ☉☉☉ (normal), ☉☉☉☉ (strong), ☉☉☉☉☉ (xstrong)	NORMAL, HIGH
Latte macchiato	Amount of milk: 3 SEC – 120 SEC Pause: 0 SEC – 60 SEC Amount of water: 25 ML – 240 ML	☉ (xmild), ☉☉ (mild), ☉☉☉ (normal), ☉☉☉☉ (strong), ☉☉☉☉☉ (xstrong)	NORMAL, HIGH
Milk portion	3 SEC – 120 SEC	–	–



Product	Amount	Coffee strength	Temp.
Milk	-	-	-
Hot water portion	25 ML – 450 ML	-	LOW, NORMAL, X HIGH
Hot water	-	-	LOW, NORMAL, X HIGH

i The products which are selected with the selector switch can be individually set to **inactive**. This means that the respective symbols are not visible and preparation is not possible.





Permanent settings in programming mode always follow the same model.

Example: Proceed as follows to change the amount of milk of latte macchiato from 15 SEC to 20 SEC, the pause from 30 SEC to 40 SEC and the amount of water from 45 ML to 40 ML.

Precondition: COFFEE READY is displayed.

- ▶ Open the cover of the Rotary Switch.
-  ▶ Keep the Rotary Switch pressed until MAINTENANCE appears.
-  ▶ Turn the Rotary Switch until PRODUCTS is displayed.
-  ▶ Press the Rotary Switch to enter the programme item.
SELECT PRODUCT

i Next select the product button for which you would like to make settings. No product is prepared during this procedure.

-  ▶ Press the Latte Macchiato button.
COFFEE 45 ML
-  ▶ Press the Rotary Switch to enter the programme item.
COFFEE 45 ML
-  ▶ Turn the Rotary Switch until COFFEE 40 ML is displayed.
-  ▶ Press the Rotary Switch to confirm the setting.

- CONFIRMED ✓ appears briefly on the display.
- COFFEE 40 ML
- ▶ Turn the Rotary Switch until MILK 16 SEC is displayed.
- ▶ Press the Rotary Switch to enter the programme item.
- MILK 16 SEC
- ▶ Turn the Rotary Switch until MILK 20 SEC is displayed.
- ▶ Press the Rotary Switch to confirm the setting.
- CONFIRMED ✓ appears briefly on the display.
- MILK 20 SEC
- ▶ Turn the Rotary Switch until PAUSE 30 SEC is displayed.
- ▶ Press the Rotary Switch to enter the programme item.
- PAUSE 30 SEC
- ▶ Turn the Rotary Switch until PAUSE 40 SEC is displayed.
- ▶ Press the Rotary Switch to confirm the setting.
- CONFIRMED ✓ appears briefly on the display.
- PAUSE 40 SEC
- ▶ Turn the Rotary Switch until EXIT is displayed.
- ▶ Press the Rotary Switch to exit the programme item.
- SELECT PRODUCT
- ▶ Turn the Rotary Switch until EXIT is displayed.
- ▶ Press the Rotary Switch to exit the programme item.
- PRODUCTS
- ▶ Turn the Rotary Switch until EXIT is displayed.
- ▶ Press the Rotary Switch to exit programming mode.
- COFFEE READY

Resetting the products to works settings

You can reset the values of all products as well as cappuccino and latte macchiato individually to the works setting.

Example: Proceed as follows to reset the values of 1 Espresso to the works setting.

Precondition: The IMPRESSA is switched off (standby).

- ▶ Open the cover of the Rotary Switch.
- ▶ Press the Rotary Switch and the 1 Espresso button for two seconds at the same time until 1 ESPRESSO OK appears.

The values of 1 Espresso are then reset to the works setting.
The IMPRESSA is switched off (standby).







Energy-saving mode (Energy Save Mode, E.S.M.®)

You can also set various energy-saving modes on your IMPRESSA:

- **SAVE NO**
 - Your IMPRESSA is continuously ready for use.
 - All coffee and milk products, as well as hot water, can be prepared without having to wait.
- **SAVE LEVEL 1**
 - Your IMPRESSA is only continuously ready for use for coffee products and hot water.
 - The machine has to heat up before milk preparation.
- **SAVE LEVEL 2**
 - Approx. 5 minutes after the last preparation the IMPRESSA switches to the energy-saving temperature and is not ready for use.
 - Before coffee, hot water or milk can be prepared, the machine has to heat up.

Example: Proceed as follows to change the energy-saving mode from **SAVE NO** to **SAVE LEVEL 1**.

Precondition: **COFFEE READY** is displayed.

- ▶ Open the cover of the Rotary Switch.
-  ▶ Keep the Rotary Switch pressed **until** **MAINTENANCE** appears.
-  ▶ Turn the Rotary Switch until **ECONOMY MODE –** is displayed.
-  ▶ Press the Rotary Switch to enter the programme item.
SAVE NO
-  ▶ Turn the Rotary Switch until **SAVE LEVEL 1** is displayed.
-  ▶ Press the Rotary Switch to confirm the setting.
CONFIRMED ✓ appears briefly on the display.
ECONOMY MODE 1
-  ▶ Turn the Rotary Switch until **EXIT** is displayed.
-  ▶ Press the Rotary Switch to exit programming mode.
COFFEE READY

Time and weekday

You already set the time and weekday when you used the machine for the first time.

Example: To change the time from **08:45** to **09:50**, proceed as follows.

Precondition: **COFFEE READY** is displayed.

- ▶ Open the cover of the Rotary Switch.
- ⌚ ▶ Keep the Rotary Switch pressed until **MAINTENANCE** appears.
- ⌚ ▶ Turn the Rotary Switch until **TIME 08:45** is displayed.
- ⌚ ▶ Press the Rotary Switch to enter the programme item.
TIME 08:45
- ⌚ ▶ Turn the Rotary Switch until **TIME 09:45** is displayed.
- ⌚ ▶ Press the Rotary Switch to confirm the hour setting.
- ⌚ ▶ Turn the Rotary Switch until **TIME 09:50** is displayed.
- ⌚ ▶ Press the Rotary Switch to confirm the minute setting.
CONFIRMED ✓ appears briefly on the display.
WEEKDAY MONDAY (Example)
- ⌚ ▶ Press the Rotary Switch to confirm the weekday setting.
CONFIRMED ✓ appears briefly on the display.
TIME 09:50
- ⌚ ▶ Turn the Rotary Switch until **EXIT** is displayed.
- ⌚ ▶ Press the Rotary Switch to exit programming mode.
COFFEE READY

Programmable switch-on and switch-off time

The programmable switch-on and switch-off time can only be set when the time has been set.















The following settings can be made in the **UNIT ON/OFF** menu item:

- **UNIT ON**
 - Set the required switch-on time.
- **NACH. OFF**
 - Set the required switch-off time.
- **ON/OFF**
 - Set the weekdays on which IMPRESSA should switch on and off automatically.

i The programmable switch-on only works when the machine is switched on at the power switch (standby).

Example: Proceed as follows to set the programmable switch-on time to **07:30** and stipulate that your IMPRESSA does **not** switch on automatically on Sundays.

Precondition: **COFFEE READY** is displayed.

- ▶ Open the cover of the Rotary Switch.
-  ▶ Keep the Rotary Switch pressed **until** **MAINTENANCE** appears.
-  ▶ Turn the Rotary Switch until **UNIT ON/OFF** is displayed.
-  ▶ Press the Rotary Switch to enter the programme item.
UNIT ON --!--
-  ▶ Press the Rotary Switch to enter the programme item.
UNIT ON --!--
-  ▶ Turn the Rotary Switch until **UNIT ON 07:00** is displayed.
-  ▶ Press the Rotary Switch to confirm the hour setting.
-  ▶ Turn the Rotary Switch until **UNIT ON 07:30** is displayed.
-  ▶ Press the Rotary Switch to confirm the minute setting.
CONFIRMED ✓ appears briefly on the display.
UNIT ON 07:30
-  ▶ Turn the Rotary Switch until **ON/OFF / MON YES** is displayed.
-  ▶ Press the Rotary Switch to enter the programme item.
ON/OFF / MON YES
-  ▶ Turn the Rotary Switch until **ON/OFF / SUN YES** is displayed.
-  ▶ Press the Rotary Switch to enter the programme item.
ON/OFF / SUN YES
-  ▶ Turn the Rotary Switch until **ON/OFF / SUN NO** is displayed.
-  ▶ Press the Rotary Switch to confirm the setting.
CONFIRMED ✓ appears briefly on the display.
ON/OFF / SUN NO
-  ▶ Turn the Rotary Switch until **EXIT** is displayed.

- ⌚ ▶ Press the Rotary Switch to exit the programme item.
ON/OFF / NON YES
- ⌚ ▶ Turn the Rotary Switch until EXIT is displayed.
- ⌚ ▶ Press the Rotary Switch to exit the programme item.
UNIT ON/OFF
- ⌚ ▶ Turn the Rotary Switch until EXIT is displayed.
- ⌚ ▶ Press the Rotary Switch to exit programming mode.
COFFEE READY

Automatic switch-off

By instructing your IMPRESSA to automatically switch itself off, you can cut down your energy consumption. If this function is activated, your IMPRESSA switches off automatically after the last action on the machine.

- i** The programmable switch-off time can be adjusted between 0.5 and 15 hours or deactivated.

Example: Proceed as follows to change the automatic switch-off time from 1 H to 2 H.

Precondition: COFFEE READY is displayed.

- ▶ Open the cover of the Rotary Switch.
- ⌚ ▶ Keep the Rotary Switch pressed until MAINTENANCE appears.
- ⌚ ▶ Turn the Rotary Switch until OFF AFTER 1 H is displayed.
- ⌚ ▶ Press the Rotary Switch to enter the programme item.
OFF AFTER 1 H
- ⌚ ▶ Turn the Rotary Switch until OFF AFTER 2 H is displayed.
- ⌚ ▶ Press the Rotary Switch to confirm the setting.
CONFIRMED ✓ appears briefly on the display.
OFF AFTER 2 H
- ⌚ ▶ Turn the Rotary Switch until EXIT is displayed.
- ⌚ ▶ Press the Rotary Switch to exit programming mode.
COFFEE READY











Rinses

You can set whether the switch-on rinse should be started manually or automatically.

You can set whether cappuccino rinsing should be prompted immediately or 10 minutes after a milk product has been prepared.

Example: Proceed as follows to programme that Cappuccino rinsing should be prompted **immediately** after a milk product has been prepared.

Precondition: **COFFEE READY** is displayed.

- ▶ Open the cover of the Rotary Switch.
-  ▶ Keep the Rotary Switch pressed **until** **MAINTENANCE** appears.
-  ▶ Turn the Rotary Switch until **RINSES** is displayed.
-  ▶ Press the Rotary Switch to enter the programme item.
INIT RINSE MANUAL
-  ▶ Turn the Rotary Switch until **CAPP RINSE AFTER 10'** is displayed.
-  ▶ Press the Rotary Switch to enter the programme item.
CAPP RINSE AFTER 10'
-  ▶ Turn the Rotary Switch until **CAPP RINSE NOW** is displayed.
-  ▶ Press the Rotary Switch to confirm the setting.
CONFIRMED ✓ appears briefly on the display.
CAPP RINSE NOW
-  ▶ Turn the Rotary Switch until **EXIT** is displayed.
-  ▶ Press the Rotary Switch to exit the programme item.
RINSES
-  ▶ Turn the Rotary Switch until **EXIT** is displayed.
-  ▶ Press the Rotary Switch to exit programming mode.
COFFEE READY

Unit amount of water / time format

You can change the unit of the amount of water from 'ml' to 'oz' and the time format to '24 HRS' or 'AM/PM'.

Example: To change the unit for the amount of water from **ML** to **OZ**, proceed as follows.

Precondition: **COFFEE READY** is displayed.

- ▶ Open the cover of the Rotary Switch.
- ⌚ ▶ Keep the Rotary Switch pressed **until** **MAINTENANCE** appears.
- ⌚ ▶ Turn the Rotary Switch until **SETTINGS 24HRS / ML** is displayed.
- ⌚ ▶ Press the Rotary Switch to enter the programme item.
SETTINGS 24HRS
- ⌚ ▶ Turn the Rotary Switch until **SETTINGS ML** is displayed.
- ⌚ ▶ Press the Rotary Switch to enter the programme item.
SETTINGS ML
- ⌚ ▶ Turn the Rotary Switch until **SETTINGS OZ** is displayed.
- ⌚ ▶ Press the Rotary Switch to confirm the setting.
CONFIRMED ✓ appears briefly on the display.
SETTINGS OZ
- ⌚ ▶ Turn the Rotary Switch until **EXIT** is displayed.
- ⌚ ▶ Press the Rotary Switch to exit the programme item.
SETTINGS 24HRS / OZ
- ⌚ ▶ Turn the Rotary Switch until **EXIT** is displayed.
- ⌚ ▶ Press the Rotary Switch to exit programming mode.
COFFEE READY

Language



You set the language when you used the machine for the first time.

Example: To change the language from **ENGLISH** to **DEUTSCH** (example), proceed as follows.

Precondition: **COFFEE READY** is displayed.

- ⌚ ▶ Keep the Rotary Switch pressed **until** **MAINTENANCE** appears.
- ⌚ ▶ Turn the Rotary Switch until **LANGUAGE ENGLISH** is displayed.
- ⌚ ▶ Press the Rotary Switch to enter the programme item.
LANGUAGE ENGLISH
- ⌚ ▶ Turn the Rotary Switch until **SPRACHE DEUTSCH** (example) is displayed.

5 Permanent settings in programming mode

- ▶  Press the Rotary Switch to confirm the setting.
`GESPEICHERT ✓` (example) appears briefly on the display.
`SPRACHE DEUTSCH` (example)
- ▶  Turn the Rotary Switch until `EXIT` is displayed.
- ▶  Press the Rotary Switch to exit programming mode.
`BITTE WAHLEN` (example)

6 Maintenance

Your IMPRESSA has the following integrated maintenance programmes:

- Rinse machine
- Change filter
- Clean machine
- Decalcify machine
- Rinse cappuccino frother
- Clean cappuccino frother

i Clean or descale the machine or change the filter whenever the appropriate prompt is displayed.

Maintenance tips

To ensure that you get many years of reliable service out of your IMPRESSA and to guarantee the optimum coffee quality, the machine requires daily maintenance.

You should proceed as follows:

- Empty the coffee grounds container and the drip tray. Rinse them with warm water.
- Rinse the water tank with clean water.
- Dismantle and rinse the frother (see Chapter 6 'Maintenance – Rinsing the cappuccino frother').
- Wipe the surface of the machine with a damp cloth.

Rinsing the machine

When the IMPRESSA is switched on, a prompt to perform a rinse operation appears after heating, or this is automatically started.

It can be set in programming mode whether the switch-on rinse needs to be activated manually or whether the machine automatically activates the switch-on rinse (see Chapter 5 'Permanent settings in programming mode – Rinses').

When the IMPRESSA is switched off, a rinse operation is automatically initiated.

You can initiate the rinse operation manually at any time.



Precondition: COFFEE READY is displayed.

- ▶ Place a receptacle under the coffee spout.
 - ▶ Open the cover of the Rotary Switch.
 - ▶ Keep the Rotary Switch pressed until MAINTENANCE appears.
 - ▶ Press the Rotary Switch to enter the programme item. CLEAN CAFFUCCINO
 - ▶ Turn the Rotary Switch until RINSE MACHINE is displayed.
 - ▶ Press the Rotary Switch to initiate the rinse operation. MACHINE RINSING
- Rinsing stops automatically and your IMPRESSA is then once more ready for use.

Changing the filter

- i** After 50 litres of water have flowed through, the filter will cease to work. Your IMPRESSA will automatically prompt you to replace the filter.
- i** After two months, the filter will cease to work. Monitor the elapsed time by adjusting the date plate on the cartridge holder.
- i** If the CLARIS filter cartridge is not activated, you will not be prompted to change the filter.

@ You can also try out 'Changing the filter' online. Visit the Knowledge Builder at www.jura.com.

Change following a prompt

To change the CLARIS filter cartridge when prompted to do so by your IMPRESSA, proceed as follows:

Precondition: COFFEE READY / CHANGE FILTER is displayed, and the maintenance button ☸ lights up.

- ☸ ▶ Press the maintenance button. DURATION 2 MIN. / START YES
- i** If you want to change the filter at a later point in time, turn the Rotary Switch until START NO is displayed. Exit the maintenance programme by pressing the Rotary Switch. The prompt 'Change filter' remains on the display.

- ⚠ ▶ Press the maintenance button.

CHANGE FILTER / PRESS RINSE

- ▶ Remove the water tank and empty it.
- ▶ Lift the cartridge holder.
- ▶ Take out the old CLARIS filter cartridge and the extension.
- ▶ Fit the extension on top of a new filter cartridge.
- ▶ Insert the filter cartridge into the water tank, exerting slight pressure.
- ▶ Close the cartridge holder. It will click into place audibly.
- ▶ Fill the water tank with fresh, cold water and reinsert.



- ▶ Place a receptacle (at least 500 ml) under the frother.

- i** If you are using the **Professional Cappuccino Frother**, set the selection lever of the frother to the steam position ☯.

- ⚠ ▶ Press the maintenance button.

FILTER RINSING, water flows out of the frother.

- i** You can interrupt filter rinsing at any time. To do this, press any button.
- i** The water may be slightly discoloured. This is not harmful to health and does not affect the taste.

Filter rinsing stops automatically after approx. 500 ml. The IMPRESSA heats up and is once again ready to use.

Manual filter change

You can initiate the 'Changing the filter' operation manually.

Precondition: The filter is activated and COFFEE READY is shown on the display.

- ▶ Open the cover of the Rotary Switch.
- ⏻ ▶ Keep the Rotary Switch pressed until MAINTENANCE appears.
- ⏻ ▶ Press the Rotary Switch to enter the programme item.
CLEAN CAPPUCCINO

- ⌚ ▶ Turn the Rotary Switch until **CHANGE FILTER** is displayed.
- ⌚ ▶ Press the Rotary Switch.
DURATION 2 MIN. / START YES
- ▶ Continue with the **second** prompt to take action (indicated by a ▶), as is described under '**Replacement following a prompt**'.

Cleaning the machine

After 220 coffee preparations or 80 switch-on rinses, the IMPRESSA will prompt you to clean it.

CAUTION

If the wrong cleaning agent is used, the machine could be damaged and/or traces of detergent could be left behind in the water.

- ▶ Use only original JURA care products.

- i** The cleaning programme only lasts about 20 minutes.
- i** Do not interrupt the cleaning programme. The quality of cleaning will be impaired if you do so.
- i** JURA cleaning tablets are available from stockists.

@ You can also try out the 'Cleaning the machine' operation online. Visit the Knowledge Builder at www.jura.com.

Cleaning following a prompt

Precondition: **COFFEE READY / CLEAN MACHINE** is displayed, and the maintenance button ☼ lights up.

- ☼ ▶ Press the maintenance button.
DURATION 20 MIN. / START YES
- i** If you want to clean the machine at a later point in time, turn the Rotary Switch until **START NO** is displayed. Exit the maintenance programme by pressing the Rotary Switch. The prompt 'Clean machine' remains on the display.
- ☼ ▶ Press the maintenance button.
EMPTY TRAY
- ▶ Empty the drip tray and coffee grounds container and put them back into the machine.
PRESS RINSE, the maintenance button ☼ lights up.

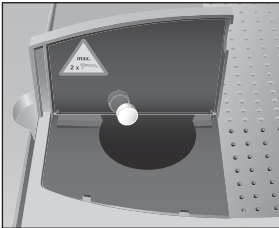

- ▶ Place a receptacle under the coffee spout and the frother.
- ⚡ ▶ Press the maintenance button.
CLEANS, the cleaning operation starts.
The process is interrupted. ADD TABLET / PRESS RINSE, the maintenance button ⚡ lights up.
- ▶ Open the cover of the filler funnel for pre-ground coffee.
- ▶ Insert a JURA cleaning tablet into the filler funnel.
- ▶ Close the cover of the filler funnel.
- ⚡ ▶ Press the maintenance button.
CLEANS, water flows out of the coffee spout and the frother several times.
- ⓘ You can follow the current status of cleaning on the progress bar.

The process is interrupted, EMPTY TRAY.
- ▶ Empty the drip tray and coffee grounds container and put them back into the machine.
The cleaning operation is now complete. The IMPRESSA is ready for use again.

Manual cleaning

You can initiate the 'Cleaning the machine' operation manually.

Precondition: COFFEE READY is displayed.

- ▶ Open the cover of the Rotary Switch.
- ⏻ ▶ Keep the Rotary Switch pressed until MAINTENANCE appears.
- ⏻ ▶ Press the Rotary Switch to enter the programme item.
CLEAN CAPPUCCINO
- ⌚ ▶ Turn the rotary switch until CLEAN MACHINE is displayed.
- ⏻ ▶ Press the Rotary Switch.
DURATION 20 MIN. / START YES
- ▶ Continue with the **second** prompt to take action (indicated by a ▶), as is described under 'Cleaning following a prompt'.

Descaling the machine

The IMPRESSA builds up deposits of limescale over time and automatically prompts you to descale it when necessary. The degree of calcification depends on the degree of hardness of your water.



If the descaling agent comes into contact with the skin or eyes, this can cause irritation.

- ▶ Avoid contact with the skin or eyes.
 - ▶ Rinse the descaling agent off with clean water. Should you get any descaling agent in your eye, see a doctor.
-

CAUTION

If the wrong descaling agent is used, the machine could be damaged and/or traces of detergent could be left behind in the water.

- ▶ Use only original JURA care products.
-

CAUTION

If the descaling operation is interrupted, there may be damage to the machine.

- ▶ Allow the descaling program to run to the end.
-

CAUTION

If the descaling agent comes into contact with sensitive surfaces, damage cannot be ruled out.

- ▶ Clean up any splashes immediately.
-

- i** The descaling programme lasts approx. 45 minutes.
- i** JURA descaling tablets are available from stockists.
- i** If you use a CLARIS filter cartridge and this is activated, you will not be prompted to change the filter.

@ You can also try out the 'Descaling the machine' operation online. Visit the Knowledge Builder at www.jura.com.

Descaling following a prompt

Precondition: COFFEE READY / DECALCIFY MACHINE is displayed and the maintenance button ☼ lights up.

- ☼ ▶ Press the maintenance button.

DURATION 45 MIN. / START YES

- i** If you want to descale the machine at a later point in time, turn the Rotary Switch until **START NO** is displayed. Exit the maintenance programme by pressing the Rotary Switch. The prompt 'Decalcify machine' remains on the display.

- ❖ ▶ Press the maintenance button.

EMPTY TRAY

- ▶ Empty the drip tray and coffee grounds container and put them back into the machine.

SOLVENT IN TANK

- ▶ Remove the water tank and empty it.
- ▶ Completely dissolve the contents of one blister (3 JURA descaling tablets) in a container that holds 600 ml of water. This may take several minutes.
- ▶ Pour the solution into the empty water tank and insert it in the machine.

SOLVENT IN TANK / PRESS RINSE, the maintenance button ❖ lights up.

- ▶ Remove the frother from the Connector System[®].
- ▶ Place a receptacle under the hot water spout and another under the Connector System[®].

- ❖ ▶ Press the maintenance button.

DECALCOS, water flows out of the Connector System[®] and the hot water spout. The maintenance button ❖ flashes during the descaling operation.

- i** You can follow the current status of descaling on the progress bar.

The process is interrupted, **EMPTY TRAY**.

- ▶ Empty the receptacles below the hot water spout and the Connector System[®].
- ▶ Empty the drip tray and coffee grounds container and put them back into the machine.

RINSE WATER TANK / FILL WATER TANK

- ▶ Remove the water tank and rinse it thoroughly.
 - ▶ Fill the water tank with fresh, cold water and reinsert.
- PRESS RINSE**, the maintenance button ❖ lights up.

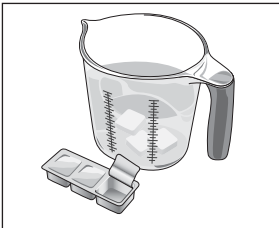



- ▶ Refit the frother.
- ▶ Place a receptacle under the coffee and hot water spout and another under the frother.
- ⚠ ▶ Press the maintenance button.
DECALCS, water flows out of the frother and the hot water spout.
 The process is interrupted, **HEATING UP**.
MACHINE RINSING, water flows out of the coffee spout. The operation stops automatically, **EMPTY TRAY**.
- ▶ Empty the drip tray and coffee grounds container and put them back into the machine.
 The descaling operation is now complete. Your IMPRESSA heats up and is once again ready to use.

i If the descaling operation stops unexpectedly, rinse the water tank thoroughly.

Manual descaling

You can initiate the 'Descaling the machine' operation manually.

Precondition: **COFFEE READY** is shown on the display and the filter is not activated.

- ▶ Open the cover of the Rotary Switch.
- 🕒 ▶ Keep the Rotary Switch pressed **until MAINTENANCE** appears.
- 🕒 ▶ Press the Rotary Switch to enter the programme item.
CLEAN CAPPUCCINO
- 🕒 ▶ Turn the Rotary Switch until **DECALCIFY MACHINE** is displayed.
- 🕒 ▶ Press the Rotary Switch.
DURATION 45 MIN. / START YES
- ▶ Continue with the **second** prompt to take action (indicated by **a▶**), as is described under '**Descaling following a prompt**'.

Rinsing the cappuccino frother

i This chapter applies to the **Professional and Easy Cappuccino Frothers**.

Each time milk has been prepared the IMPRESSA displays a prompt for Cappuccino rinsing.

It can be set in programming mode whether the rinsing prompt is displayed **immediately** or **10 minutes** after preparation (refer to Chapter 5 'Permanent settings in programming mode – Rinses').

Rinsing following a prompt



Precondition: **COFFEE READY / RINSE CAPPUCCINO** is displayed and the maintenance button  lights up.

- ▶ Place a receptacle under the frother.

i If you are using the **Professional Cappuccino Frother**, turn the selection lever to the steam position .

-  ▶ Press the maintenance button.

CAPPU. RINSING, the frother is rinsed.

The procedure stops automatically. **COFFEE READY** appears on the display.

Starting rinsing manually







You can initiate the 'Rinsing the cappuccino frother' operation manually.

Precondition: **COFFEE READY** is displayed.

- ▶ Place a receptacle under the frother.

i If you are using the **Professional Cappuccino Frother**, turn the selection lever to the steam position .

- ▶ Open the cover of the Rotary Switch.
-  ▶ Keep the Rotary Switch pressed until **MAINTENANCE** appears.
-  ▶ Press the Rotary Switch to enter the programme item. **CLEAN CAPPUCCINO**
-  ▶ Turn the Rotary Switch until **RINSE CAPPUCCINO** is displayed.
-  ▶ Press the Rotary Switch to start the rinse operation. **CAPPU. RINSING**, the frother is rinsed. The procedure stops automatically. **COFFEE READY** appears on the display.

Cleaning the cappuccino frother

i This chapter applies to the **Professional and Easy Cappuccino Frothers**.

To ensure that the respective frother works perfectly, you should clean it **daily** when you have been preparing milk.

CAUTION

If the wrong cleaning agent is used, the machine could be damaged and/or traces of detergent could be left behind in the water.

- ▶ Use only original JURA care products.





i The IMPRESSA will not prompt you to clean the frother.



i The JURA Cappuccino Cleaner is available from stockists.

@ You can also try out the 'Cleaning the cappuccino frother' operation online. Visit the Knowledge Builder at www.jura.com.

Cleaning the cappuccino frother – manually

Precondition: COFFEE READY is displayed.

- ▶ Open the cover of the Rotary Switch.
-  ▶ Keep the Rotary Switch pressed **until** MAINTENANCE appears.
-  ▶ Press the Rotary Switch to enter the programme item.
CLEAN CAPPUCCINO
-  ▶ Press the Rotary Switch.
CLEANER FOR CAPPU., the maintenance button  lights up.
- ▶ Pour 250 ml of fresh water into a container and add one capful (max. 15 ml) of Cappuccino Cleaner.
- ▶ Immerse the milk pipe in the receptacle with the cleaning solution.

i If you are using the **Professional Cappuccino Frother**, turn the selection lever to the milk foam  or milk  position.



Cleaning the cappuccino frother after a prompt

- ▶ Place another receptacle under the frother.
- ⚠ ▶ Press the maintenance button.
CAPPUCCINO / CLEANS, the frother and pipe are cleaned.
WATER FOR CAPPUCCINO, the maintenance button ⚠ lights up.
- ▶ Rinse the receptacle thoroughly, fill it with approx. 250 ml of fresh water and immerse the milk pipe in the water.
- ▶ Empty the other receptacle and place it under the frother once more.
- ⚠ ▶ Press the maintenance button.
CAPPUCCINO / CLEANS, the frother and pipe are rinsed with fresh water.
COFFEE READY appears on the display. Your IMPRESSA is once more ready to use.

If milk has been prepared, but the cappuccino frother has not been cleaned, the **CLEAN CAPPUCCINO** prompt is displayed when the machine is switched off. The maintenance programme can be started by pressing the maintenance button ⚠.

Precondition: **CLEANER FOR CAPPU.** is displayed and the maintenance button ⚠ lights up.

- ▶ Continue with the **fifth** prompt to take action (indicated by a ▶), as is described under 'Cleaning the cappuccino frother – manually'.

Disassembling and rinsing the Professional Cappuccino Frother

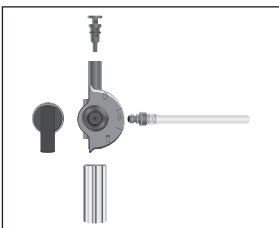

- ▶ Carefully remove the frother from the Connector System® by twisting slightly.
- ▶ Dismantle the frother completely.
- ▶ Rinse all the frother parts thoroughly under running water.
- ▶ Reassemble the frother.

Disassembling and rinsing the Easy Cappuccino Frother

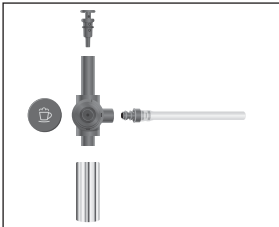

i Ensure that the individual parts are correctly and firmly attached to one another to ensure optimum function of the frother.

▶ Firmly attach the frother to the Connector System®.

▶ Carefully remove the frother from the Connector System® by twisting slightly.

▶ Dismantle the frother completely.

▶ Rinse all the frother parts thoroughly under running water.

▶ Reassemble the frother.

i Ensure that the individual parts are correctly and firmly attached to one another to ensure optimum function of the frother.

▶ Firmly attach the frother to the Connector System®.

Cleaning the bean container



Coffee beans may be covered with a slight oil film which remains on the walls of the bean container. These residues may negatively affect the coffee results. For this reason clean the bean container from time to time.

Danger of injury to the fingers when the grinder is running.

▶ Switch the machine off with the on/off button  before performing any work on the grinder.

▶ Switch the machine off at the power switch .

▶ Open the cover of the bean container and remove the aroma preservation cover.

▶ Remove the beans with a vacuum cleaner.

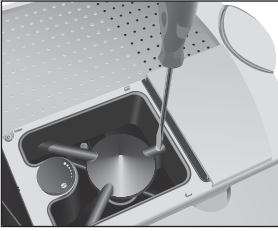

- ▶ Loosen the screw in the bean container and lift up the finger protection.
- ▶ Remove the remaining beans with a vacuum cleaner.
- ▶ Clean the bean container with a soft, dry cloth.
- ▶ Put the finger protection down again and screw it back tightly in place.
- ▶ Fill the bean container with coffee beans, then close the aroma preservation cover and the bean container cover.

Limescale deposits may form in the water tank. To ensure correct function of your IMPRESSA, you should descale the water tank from time to time.

Descaling the water tank

- ▶ Remove the water tank.
- ▶ If you use a CLARIS filter cartridge, remove this.
- ▶ Descale the tank with a mild, commercially available descaling agent in accordance with the instructions of the manufacturer.
- ▶ Rinse the water tank with clean water afterwards.
- ▶ If you use a CLARIS filter cartridge, insert this again.
- ▶ Fill the water tank with fresh, cold water and reinsert.

7 Display messages

Message	Cause/Result	Action
FILL WATER TANK	The water tank is empty. You cannot prepare any coffee products, hot water or milk products.	▶ Fill the water tank (see Chapter 2, 'Preparing and using for the first time – Filling the water tank').
EMPTY GROUNDS	The coffee grounds container is full. You cannot prepare any coffee products, but you can prepare hot water or milk.	▶ Empty the coffee grounds container and the drip tray.
EMPTY TRAY	The drip tray is full. You cannot prepare any coffee products, hot water or milk products.	▶ Empty the drip tray.
TRAY MISSING	The drip tray is not inserted correctly or is not inserted at all. You cannot prepare any coffee products, hot water or milk products.	▶ Insert the drip tray. ▶ Clean the metal contacts on the back of the drip tray.
FILL BEANS	The bean container is empty. You cannot prepare any coffee products, but you can prepare hot water or milk.	▶ Fill the bean container (see Chapter 2, 'Preparing and using for the first time – Filling the bean container').
PRESS RINSE	The IMPRESSA is prompting you to start a rinse operation or continue a started maintenance programme.	▶ Press the maintenance button to start rinsing or to continue the maintenance programme.
COFFEE READY / RINSE CAPPUCCINO	The IMPRESSA is prompting you to start cappuccino rinsing.	▶ Press the maintenance button to start cappuccino rinsing.
COFFEE READY / CLEAN MACHINE	After 220 preparations or 80 switch-on rinses, the IMPRESSA will prompt you to clean it.	▶ Clean the machine (see Chapter 6, 'Maintenance – Cleaning the machine').

Message	Cause/Result	Action
COFFEE READY / CLEAN NOW	After 250 preparations the IMPRESSA will prompt you to clean it.	► Clean the machine (see Chapter 6, 'Maintenance – Cleaning the machine').
COFFEE READY / DECALCIFY MACHINE	The IMPRESSA is prompting you to descale it.	► Descal the machine (see Chapter 6, 'Maintenance – Descaling the machine').
COFFEE READY / DECALCIFY NOW	The IMPRESSA is prompting you to descale it.	► Descal the machine (see Chapter 6, 'Maintenance – Descaling the machine').
COFFEE READY / CHANGE FILTER	After 50 litres of water have flowed through, or after two months, the filter will cease to work.	► Replace the CLARIS filter cartridge (see Chapter 6 'Maintenance – Changing the filter').
COFFEE READY / CHANGE NOW	After 55 litres of water have flowed through, the filter will cease to work.	► Replace the CLARIS filter cartridge (see Chapter 6 'Maintenance – Changing the filter').
NOT ENOUGH PRE-GROUND	There is too little pre-ground coffee in the filler funnel. The IMPRESSA stops the operation.	► The next time you make coffee use more pre-ground coffee (refer to Chapter 4, 'Preparation at the touch of a button – Pre-ground coffee').

8 Troubleshooting

Problem	Cause/Result	Action
Grinder is making a very loud noise.	There are foreign objects in the grinder.	▶ Contact Customer Support in your country (see 'JURA contact details / Legal information').
The frother does not produce enough milk foam or milk sprays from the cappuccino frother.	The cappuccino frother is dirty or incorrectly attached.	<ul style="list-style-type: none"> ▶ Rinse and clean the cappuccino frother (see Chapter 6, 'Maintenance – Cappuccino frother'). ▶ Assemble the cappuccino frother correctly and firmly attach the frother to the Connector System® (refer to Chapter 6 'Maintenance – Disassembling and rinsing the frother').
Coffee only comes out in drips when it is being prepared.	Coffee or pre-ground coffee has been ground too finely and is blocking the system.	▶ Put the grinder on a coarser setting or use coarser pre-ground coffee (refer to Chapter 2, 'Preparing and using for the first time – Adjusting grinder').
Water hardness cannot be adjusted.	The CLARIS filter cartridge is activated.	▶ Deactivate the CLARIS filter cartridge in programming mode.
COFFEE READY / FILL BEANS is displayed although the bean container has been filled.	The grinder is not yet completely filled with beans.	▶ Prepare a coffee speciality.
COFFEE READY / FILL BEANS is not displayed although the bean container is empty.	The bean monitor is dirty.	▶ Clean the bean container (see Chapter 6, 'Maintenance – Cleaning the bean container').
EMPTY TRAY is always displayed.	The metal contacts of the drip tray are dirty or wet.	▶ Clean and dry the metal contacts on the back of the drip tray.
FILL WATER TANK is displayed although the water tank is full.	The water tank float is trapped.	▶ Descale the water tank (see Chapter 6, 'Maintenance – Descaling the water tank').

Problem	Cause/Result	Action
ERROR 2 is displayed.	If the machine was exposed to the cold for a long period of time, it is disabled from heating up due to safety reasons.	► Warm up the machine at room temperature.
Other ERROR messages are displayed.	–	► Turn the IMPRESSA off at the power switch. Contact Customer Support in your country (see 'JURA contact details / Legal information').

- i** If you have not been able to solve the problem, contact Customer Support in your country (see 'JURA contact details / Legal information').

9 Transport and environmentally neutral disposal

Transport/Emptying the system

Keep the packaging for your IMPRESSA. It should be used to protect the machine during transportation.

In order to protect the IMPRESSA from frost during transportation, the system must be emptied.



Precondition: The IMPRESSA is switched off (standby).

- ▶ Remove the water tank.
- ▶ Place a receptacle under the hot water spout and another under the frother.
- ❖ ▶ Press the maintenance button **until** **SYSTEM EMPTYING** appears.

A small amount of water flows from the frother and the hot water spout. The operation stops automatically. The IMPRESSA will switch itself off.

- ▶ Turn your IMPRESSA off at the power switch.

i The next time you use the machine the system must be refilled (see Chapter 2, 'Preparing and using for the first time – First-time use').









Disposal

Please dispose of old machines in an environmentally neutral way.



Old machines contain valuable materials capable of being recycled which should be salvaged for recycling. Please therefore dispose of old machines via your regional collection system.

10 Technical data

Voltage		230 V AC, 50 Hz
		120 V AC, 60 Hz
		220 –240 V AC, 50 Hz
		220 V AC, 50 Hz
Power		1450 W
		1250 W
Safety test	   	
Energy SAVE NO		23 Wh
Energy SAVE LEVEL 1		16 Wh
Energy SAVE LEVEL 2		14 Wh
Energy consumption in standby mode		5.6 Wh
Pump pressure		Static max. 15 bar
Holding capacity of water tank		2.8 l
Holding capacity of bean container		280 g
Holding capacity of coffee grounds container		Approx. 20 servings
Cable length		Approx. 1.1 m
Weight		13.3 kg
Dimensions (W x H x D)		31 x 37 x 43.5 cm

Index

A

- Addresses 72
- Aroma preservation cover 8
- Automatic switch-off 47

B

- Bean container
 - Aroma preservation cover 8
 - Cleaning 62
 - Cover 8
 - Filling 17

C

- Cappuccino 34
 - With the Easy Cappuccino Frother 34
 - With the Professional Cappuccino Frother 34
- Cappuccino frother
 - Cleaning 60
 - Easy Cappuccino Frother 16
 - Professional Cappuccino Frother 16
 - Rinsing 58
- CLARIS filter cartridge
 - Changing 52
 - Using and activating 19
- Cleaning
 - Bean container 62
 - Cappuccino frother 60
 - Machine 54
- Coffee 33
- Coffee à la carte 33
- Coffee grounds container 8
- Coffee spout, height-adjustable 8
- Connector System® 8, 16
- Contact details 72
- Control options 25
- Cover
 - Bean container 8
 - Filler funnel for pre-ground coffee 8
- Customer support 72

D

- Default settings in programming mode 41
- Descaling
 - Machine 56
 - Water tank 63
- Display messages 64

- Display, Messages 64
- Drip tray 8

E

- Easy Cappuccino Frother
 - Disassembling and rinsing 62
- Emptying the system 68
- Energy-saving mode 44
- Entering a default setting for the amount of water for a cup size 27
- Errors
 - Troubleshooting 66
- Espresso 32

F

- Filler funnel for pre-ground coffee 8
- Filling
 - Bean container 17
 - Water tank 17
- Filter
 - Changing 52
 - Using and activating 19
- Fineness of grind
 - Adjusting grinder 22
 - Fineness of grind switch 8
- Fineness of grind switch 8
- First-time use 18
- Frother
 - Easy Cappuccino Frother 16
 - Professional Cappuccino Frother 16

H

- Hardness of water 21
- Hot milk 37
- Hot water 39
 - Hot water portion 39
- Hot water spout 8

I

- Internet 16

J

- JURA contact details 72

K

- Knowledge Builder 16

L

- Language 49
- Latte macchiato 35
 - With the Professional Cappuccino Frother 35, 36

Legal information 72

M

Machine

- Cleaning 54
- Descaling 56
- Rinsing 51
- Setting up 17
- Switching off (stand-by) 24
- Switching on 23

Maintenance 51

- Maintenance tips 51

Milk

- Foaming and heating with the Professional Cappuccino Frother 38
- Foaming with the Easy Cappuccino Frother 39
- Hot 37
- Milk portion 37

Milk foam 37

O

One-off settings before and during preparation 26

P

Power switch 8

Pre-ground coffee 37

- Filler funnel 8
- Pre-ground coffee 37

Preparation

- At the touch of a button 32
- Cappuccino 34
- Coffee 33
- Coffee à la carte 33
- Espresso 32
- Hot water 39
- Latte macchiato 35
- Milk 37
- Pre-ground coffee 37

Problems

- Troubleshooting 66

Professional Cappuccino Frother 8, 16

- Disassembling and rinsing 61

Programmable switch-on and switch-off time 45

Programming mode 41

- Automatic switch-off 47
- Energy-saving mode 44

Language 49

Products 41

Rinses 48

Switch-on and switch-off time 45

Time and weekday 45

Unit amount of water/Time format 48

R

Rinses 48

Rinsing

- Cappuccino frother 58
- Machine 51

Rotary Switch 9

S

Safety 10

Selector switch 9

Settings

- Default settings in programming mode 41
- Entering a default setting for the amount of water for a cup size 27
- One-off settings before and during preparation 26

Setting up 17

Standby

- Switching off 24

Switching off (stand-by) 24

Switching on 23

T

Technical data 69

Time and weekday 45

Troubleshooting 66

U

Use

- Proper 10
- Use, First time 18

V

Viewing information and maintenance status 31

Viewing maintenance status 31

W

Water hardness 21

- Determining and adjusting 21

Water tank 8

- Descaling 63
- Filling 17

Works settings 43

JURA contact details / Legal information

JURA Elektroapparate AG
Kaffeeweltstrasse 10
CH-4626 Niederbuchsiten
Phone: +41 62 38 98 233

@ Contact information is available on the company website at www.jura.com.

Directives

The machine complies with the following EU directives:

- 2006/95/EC – Low Voltage Directive
- 2004/108/EC – Electromagnetic Compatibility

Technical changes

We reserve the right to make technical changes.

The illustrations used in the IMPRESSA S9 One Touch Manual show the IMPRESSA S9 Platinum model. Your IMPRESSA could incorporate minor changes.

Feedback

Your opinion is important to us!
Use the contact link at www.jura.com.

Copyright

The Instructions for Use contain information which is protected by copyright. It is not permitted to photocopy or translate these Instructions for Use into another language without the express written consent of JURA Elektroapparate AG.